



# KODAK Mini Shot 4 Era Instant Camera and Photo Printer MS400

User Guide      Guide de l'utilisateur      Kasutusjuhend      Podręcznik użytkownika      Benutzerhandbuch      ユーザーガイド  
 guía del usuario      Uživatelská příručka      사용자 설명서      Naudotojo gidas      Användarguide      用户指南  
 Guida dell'utente      Uživatelská príručka      Käyttöohjeet      Lietotāja rokasgrāmata      Brugervejledning



Made in Korea



www.kodakphotoprinter.com



If you encounter any issues or have any questions, our customer service team is available 24/7 right by your side.

## THANK YOU

GRACIAS    MERCI    VIELEN    DANK    GRAZIE    Dank je  
 감사합니다    谢谢    Спасибо    ありがとうございます

### LIMITED ONE YEAR WARRANTY ON KODAK PHOTO PRINTER AND CARTRIDGE

Product	Duration of limited warranty
KODAK Instant Camera and Printer	1year
Refill Cartridge of KODAK Instant Camera and Printer	1year

#### Limitation of warranty and liability

To the extent allowed by local law, neither Prinics nor its third-party suppliers makes any other warranty or condition of any kind, whether express, oral, written, statutory or implied warranties or conditions of merchantability, satisfactory quality and fitness for a particular purpose. We disclaim all other warranties, expressed or implied, statutory or otherwise, including without limitation, the warranties of merchantability for a particular purpose. Some states do not allow disclaimers of implied warranties, so this disclaimer may not apply to you. To the extent such warranties cannot be disclaimed under the laws of your jurisdiction. We limit the duration and remedies of such warranties to the duration of this express limited warranty.

Our responsibility for defective goods is limited to repair replacement or refund as described below in this warranty statement.

Prinics Co., Ltd("We") may use this warranty. We extend this limited warranty only to the consumer who originally purchased the product ("you"). It does not extend to any subsequent owner or other transferee of the product.

This limited warranty does not cover any damage due to: (a) transportation; (b) storage; (c) improper use; (d) failure to follow the product instructions or to perform any preventive maintenance; (e) modifications; (f) unauthorized repair; (g) normal wear and tear; or (h) external caused such as accidents, abuse, or other actions or events beyond our reasonable control.

#### Extent of limited warranty

This Limited warranty applies to above mentioned products. We warrant that above products specified will be free from defects in materials and workmanship for the duration specified above, which Limited Warranty Period begins on the date of product. If we receive during the applicable warranty period, notice of a defect in any product which is covered by the warranty, we shall either repair or replace the product at our option. We shall have no obligation to repair and replace until the customer returns the defective product to us.

To obtain warranty service, you must contact us by email at support@kodakphotoprinter.com for supports during the warranty period to obtain a defective merchandise authorization ("DMA") number. Please note that customer is responsible for shipping charges for service request. No warranty service will be provided without a DMA number

www.kodakphotoprinter.com

Made in Korea  
 @Prinics Co., LTD.



The Kodak trademark, logo and trade dress are used under license from Kodak.

## Any questions?

In case you need any assistance, please send an email to [support@kodakphotoprinter.com](mailto:support@kodakphotoprinter.com).

The Kodak trademark, logo and trade dress are used under license from Kodak. [www.kodakphotoprinter.com](http://www.kodakphotoprinter.com)

### FCC (Federal Communications Commission)





This device complies with part 15 of the FCC Rules. Operation is subject to the following two conditions:  
 (1) This device may not cause harmful interference, and  
 (2) This device must accept any interference received, including interference that may cause undesired operation.





Caution: Any changes or modifications to the equipment not expressly approved by the party responsible for compliance could void user's authority to operate the equipment.



This appliance and its antenna must not be co-located or operation in conjunction with any other antenna or transmitter. A minimum separation distance of 20cm must be maintained between the antenna and the person for this appliance to satisfy the RF exposure requirements.





 

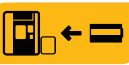

**KODAK Photo Printer** 

  Available on the  **App Store**  
 **Google play**



 

**1** 

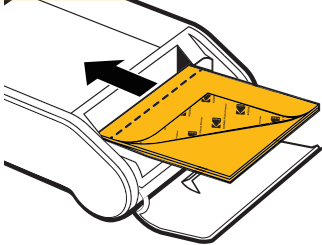

**2** 



 

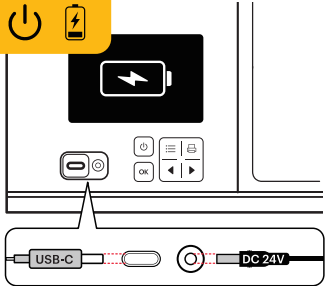

 





USB-C  DC 24V 

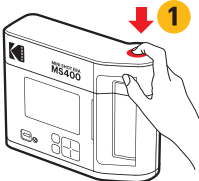

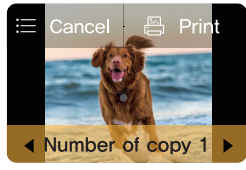



**1** 

 Cancel Print  
 Number of copy 1



**2** 

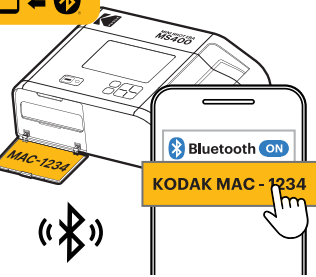



 

 

Bluetooth ON  
 KODAK MAC - 1234

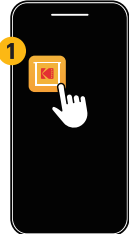

**1** 

**2** 

**3** 





**4** 

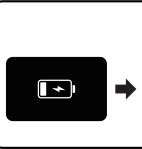
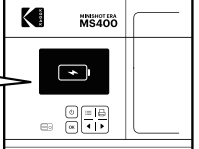





**i - 1**  **60 ~ 90 MIN**



 

**i - 2**

    

**⚠ - 1**

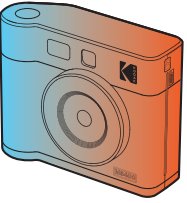

 

41-113°F  
 5-45°C 

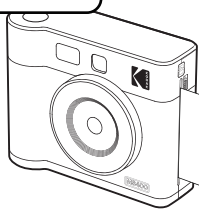

**⚠ - 2**



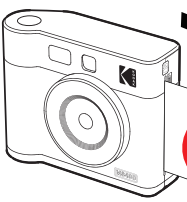

**⚠ - 3**

**⚠ - 4**

**⚠ - 5**





<https://support.kodakphotoprinter.com>