

Kodak

PIXPRO WP1

Sport Camera

User Manual



BEFORE YOU START

Declaration of Conformity

Responsible Party: JK Imaging Ltd.

Address: JK Imaging Ltd., 17239 So. Main Street, Gardena, CA 90248 USA

JK Imaging Europe, 71 Clarendon Road, Watford, WD17 1DS, UK

Company website: <http://kodakpixpro.com>

For Customers in the U.S.A.

Tested to Comply with FCC Standards FOR HOME OR OFFICE USE

This device complies with part 15 of the FCC Rules. Operation is subject to the following two conditions: (1) This device may not cause harmful interference, and (2) this device must accept any interference received, including interference that may cause undesired operation.

For Customers in Europe

 "CE" mark indicates that this product complies with the European requirements for safety, health, environment and customer protection. "CE" marked cameras are intended for sales in Europe.



This symbol [crossed-out wheel bin WEEE Annex IV] indicates separate collection of electrical waste and electronic equipment in the European countries. Please do not throw the equipment into domestic refuse. Please use the return and collection systems available in your country for proper, safe disposal of this product.

About this Manual

Thank you for purchasing this KODAK PIXPRO Sport Camera. Please read this manual carefully and keep it in a safe place for future reference.

- JK Imaging Ltd. reserves all rights of this document. No part of this published manual may be reproduced, transmitted, transcribed, stored in a retrieval system or translated into any language or computer language, in any form, by any means, without the prior written permission of JK Imaging Ltd..
- All trademarks mentioned in this manual are used for identification purposes only and are properties of their respective owners.
- This manual will instruct you on how to operate the KODAK PIXPRO Sport Camera. JK Imaging Ltd. has tried its utmost to ensure the correctness of the user manual contents, but reserves the right to modify as necessary. All of these contents are subject to change without prior notice.
- Throughout this manual, the following symbols are used to help you locate information quickly and easily:



Indicates useful information.

- In the instructions below, the following symbols may be used throughout this manual on how to operate the camera. This is to facilitate better understanding.

[Item properties] : The optional properties in the camera interface are indicated by the symbol [] .

Safety Notes

Waterproof / Dustproof / Shockproof

- JIS / IEC waterproof grade 8 (IPX8).
- JIS / IEC dustproof grade 6 (IP6X).
- Height for shockproof rating is 1.2m.

Waterproofing Notes:

- Do not use the product below 5 meters (16.4 feet) underwater. The product will remain waterproof for one hour at the depth of 5m (16.4 feet).
- Do not use this product in a geothermal spring or in water at a temperature greater than 40 °C.
- Please do not open the battery cover and side cover underwater.
- If water accidentally comes in contact with the product, please do not open the battery cover and side cover immediately. Turn the product off, and dry it with a clean, dry and lint free cloth. Then open the battery cover and side cover, and remove the battery and the memory card.
- When opening the battery cover and side cover, if there are water drops on the contact surface between the inside of the battery cover and side cover and the body, please dry the water drops.
- After using the product in water or near sand, mud or other foreign materials, please rinse it with clean water (close the battery cover and side cover when cleaning). After cleaning, dry the product with a clean, dry and lint free cloth.
- If there is dust, sand or other foreign materials on the waterproof rubber of the battery cover and side cover and its contact surface, please wipe it with a clean, dry and lint free cloth as soon as possible.
- Before using the product underwater, make sure that there is no damage to or foreign debris on the waterproof rubber gasket. Then close the battery cover and side cover tightly to ensure the waterproof capability of the product.



Waterproof rubber with scratches and cracks will allow water to penetrate into the product. Contact customer service immediately for maintenance with replacement of new waterproof rubber.

Safety notes for this camera

- Do not drop the camera or hit it with solid objects.
- Do not attempt to disassemble the camera.
- Avoid using or storing the camera in direct sunlight or in locations where it may be exposed to rapid changes in temperature or to condensation.
- Keep the product away from powerful magnetic field, for example near a magnet or transformer.
- Condensation may occur inside if the camera is taken from a cold place to a hot environment. Please wait for some time before you turn it on.
- Before you remove the battery and memory card, the camera should be turned off.
- Use a professional lens wiping cloth and dedicated cleaner to wipe and clean the lens.
- Recommend download photos, videos from the camera every time after usage. Remove memory card from camera that will be stored unused for extended periods.
- If this camera is not in use for a long time, please keep it in a dry and clean condition.
- The company and manufacture will not be responsible for pictures or video files loss due to improper operation or storage.

Safety notes for battery

- If battery leaks, contact our customer service. Do not touch leaking batteries directly; wear protective material to remove the batteries and dispose of them properly immediately.
- Comply and dispose of batteries according to the local laws and regulations of your region. Some batteries may be recycled, and may be accepted for disposal at your local recycling center.
- Do not disassemble, puncture, modify, drop, throw, or cause other unnecessary shocks to batteries.
- Do not let the battery come in contact with metal objects (including coins) to avoid short circuiting, discharging, excessive heat, or possible leakage.
- Do not place batteries into a microwave oven, or into any other high-pressure container. Do not immerse batteries in water or otherwise get them wet.
- Do not heat the battery or throw it into a fire to avoid a possible explosion.
- Do not store batteries near an oven, stove, or other heat source.
- Do store batteries in a cool, dry place at normal room temperature. Remove batteries from devices that will be stored unused for extended periods.
- In a colder environment, the performance of the battery could be noticeably reduced.
- When you install the battery, install it according to the positive and negative markings on the battery compartment. Never force it into the battery compartment.

Safety notes for memory card

- The memory card referred to in this manual is a microSD Card or microSDHC card.
- Legitimate well-known brand memory cards are recommended.
- Please format the memory card with the camera before you use it or replace it with a new one.
- Do not drop the memory card or allow it to hit solid objects to avoid damaging it.
- Do not attempt to disassemble or repair the memory card.
- Do not expose the memory card to water. Always keep it dry.
- Do not remove the memory card when the camera is turned on. Otherwise, the memory card could be damaged.
- Files in memory card shall not be edited directly. To edit, please copy them to your PC hard disk first.
- If it is not used for a long time, the data on the card may become unreadable. Be sure to regularly make a backup of important data on a computer.
- To prevent failure of identification or identification error for original folders or files on camera, please do not change the name of the files or folders in the memory card on your computer.
- Photos taken with the camera will be saved in the folder automatically created in the memory card. Don't save other photos that are not taken by this camera in this folder so as to prevent failure of identification when replaying on the camera.
- When you insert a memory card, make sure the notch of the card matches the markings on the top of the card slot.

Other Notes

- Do not disconnect the power or turn the product off during the update process. Doing so may cause incorrect data to be written and the product may not power on later.
- When using your product on an airplane, observe the relevant rules specified by the airline.
- Due to the limitations of manufacturing technology, the LCD screen may have a few dead or bright pixels. These pixels do no effect the quality of the photos or video.
- If the LCD screen is damaged, pay particular attention to the liquid crystal in the screen. If any of the following situations arise, take the recommended immediate action indicated below:
 1. If liquid crystal comes in contact with your skin, please wipe with a dry cloth, wash thoroughly with soap, and rinse with plenty of clean water.
 2. If liquid crystal gets into your eye, flush the eye immediately with plenty of clean water for at least 15 minutes and then seek for medical assistance.
 3. If liquid crystal is swallowed, immediately flush your mouth thoroughly with clean water and induce vomiting. Seek for medical assistance.

CONTENTS

BEFORE YOU START	1
Safety Notes	3
CONTENTS.....	8
GETTING READY	12
Accessories Included.....	12
Part Names	13
Installing Battery	15
Installing Memory Card	16
Turn On / Off the Camera	17
Set up Language/ Date / Time.....	17
MODE OVERVIEW	20
LCD Screen Display.....	20
Overview of the screen icons in photo shooting mode	20
Overview of the Screen Icons in Movie Mode.....	22
Using the Mode Button	23

Auto Mode.....	24
Manual Mode.....	24
Portrait Mode.....	25
Panorama Mode	25
Scene Mode.....	27
BASIC OPERATION.....	30
Display Setting.....	30
Self-Timer Setting.....	31
Flash Mode	32
EV Setting.....	33
Using Quick Recording.....	35
PLAYBACK.....	36
Overview of the Screen Icons in Playback Mode.....	36
Viewing Photos and Videos.....	37
Thumbnail View.....	38
Using Zoom Playback (for still pictures only).....	39

Slideshow	40
Photos and Video Deletion	41
USING THE MENUS	42
Photo Setup Menu.....	42
Photo Shooting Setting Menu.....	48
Movie Menu	51
Movie Setting Menu	53
Playback Menu	54
Playback Setting Menu.....	57
General Settings	61
Sound Settings	62
Power Saver	62
Language	63
Zone.....	63
Date/Time	63
File Settings	64
Format Memory	64

Copy to Card.....	65
File Numbering.....	65
Reset.....	66
FW Version	66
CONNECTIONS.....	67
Connecting to a Computer	67
Video System	68
Battery Type.....	69
Connecting to a PictBridge Compatible Printer	70
Using the PictBridge Menu.....	72
APPENDICES.....	76
Specifications	76
Prompts and Warning Messages.....	80
Troubleshooting.....	83

GETTING READY

Accessories Included

Your camera box should contain the camera model you purchased along with the following accessories. If anything is missing or appears to be damaged, please contact your retailer.

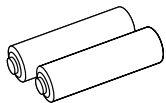

AA Alkaline battery × 2

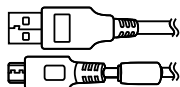

Micro USB cable



Wrist strap



Quick start guide



Warranty card



Service card

Part Names

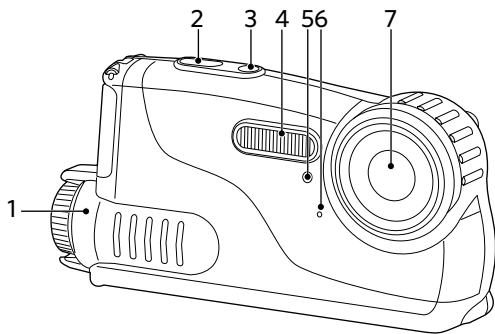

1. Battery cover
2. Shutter button
3. Power button
4. Flash lamp
5. Self-timer lamp
6. Microphone
7. Lens

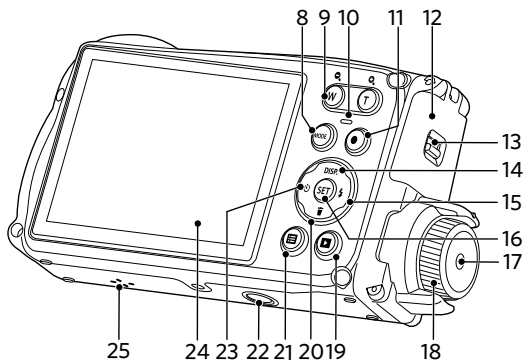

- 8. Mode button
- 9. Zoom button
- 10. Indicator lamp
- 11. Fast video recording button
- 12. Side cover
- 13. Side cover lock
- 14. Display button/Up button
- 15. Flash button/Right button
- 16. SET button
- 17. Battery cover button
- 18. Battery cover knob
- 19. Playback button
- 20. Delete button/Down button
- 21. Menu button
- 22. Tripod socket
- 23. Self-timer button/Left button
- 24. LCD
- 25. Speaker

Installing Battery

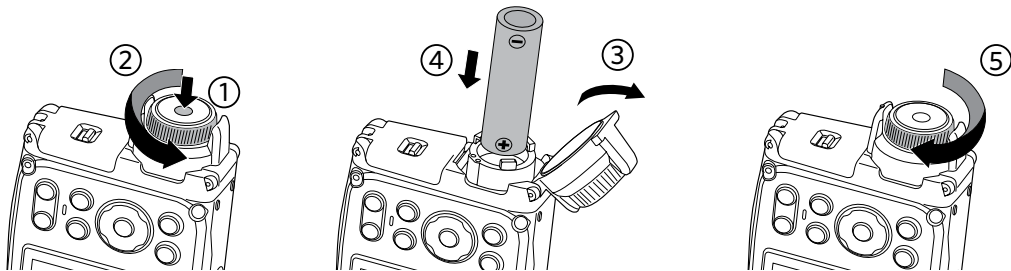

1. Press the battery cover button and rotate the knob counterclockwise to open the battery cover.
2. Install two AA batteries in the battery compartment.
3. Close the battery cover and rotate the knob clockwise to lock.

Installing Memory Card

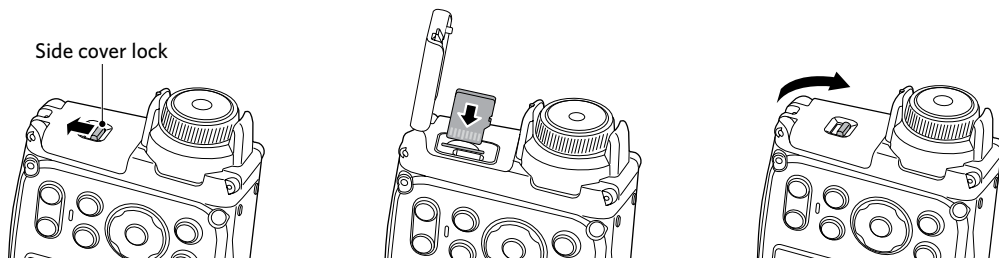

1. Push the side cover lock as the arrow shown.
2. Correctly insert the memory card into the slot as the diagram shown.
3. Close the side cover.



The memory card (microSD/microSDHC) is optional and not included in all camera packaging. If you have to purchase a memory card, select one with storage capacity between 4GB and 32GB to ensure correct data storage.



To remove your memory card, open the side cover, gently press the memory card to eject it and remove it carefully.

Turn On / Off the Camera

Press the Power button to turn the camera on. To turn the camera off, press the Power button again.

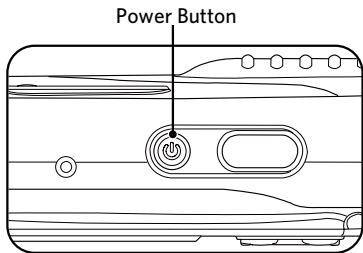

When the camera power is off, pressing the playback button can power on the camera and directly enter playback mode.









Set up Language/ Date / Time

Set your Language, Date/Time after the first power-on

1. When you turn the camera on for the first time, the language selection screen appears.
2. Press the arrow buttons to select your desired language.
3. After you press the **SET** button to confirm the selection, the Date/Time settings screen appears.
4. Press the left/right arrow button to select the Date/Time to be adjusted: Time is displayed in yyyy:MM:dd HH:mm.
5. Press the up/down arrow button to adjust the value for the selected Date/Time.
6. Press the **SET** button to confirm the time settings and the snapshot screen appears.

Resetting your Language









After you set your language for the first time, follow the instructions below to reset your language.

1. Press the Power button to turn the camera on.
2. Press the  button, press the up/down arrow button to select , and press the  button to enter the menu.
3. Press the up/down arrow button to select , and press the  button or right arrow button to enter the menu.
4. Press the up/down arrow button to select [Language] and press the  button or right arrow button to enter the menu.
5. Press the arrow buttons to select your desired language and press the  button to confirm.
6. Press the  button and the snapshot screen appears.



Resetting Date/Time

After you set your Date/Time for the first time, follow the instructions below to reset date and time.

1. Press the Power button to turn the camera on.
2. Press the  button, press the up/down arrow button to select , and press the  button to enter the menu.
3. Press the up/down arrow button to select , and press the  button or right arrow button to enter the menu.
4. Press the up/down arrow button to select [Date & Time] and press the  button or right arrow button to enter the menu.
5. Press the left/right arrow button to select the Date/Time to be adjusted: Time is displayed in yyyy:MM:dd HH:mm.
6. Press the up/down arrow button to press the value for your selected block. After you finish your settings, press the  button to confirm.
7. Press the  button and the following snapshot screen appears.



MODE OVERVIEW

LCD Screen Display

Overview of the screen icons in photo shooting mode

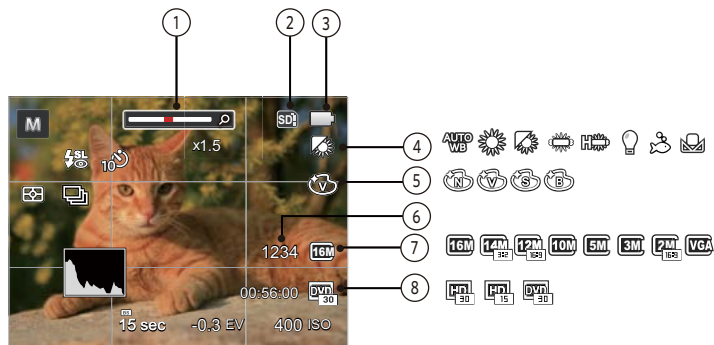

1	Zoom Display	5	Color Effect
2	Memory Card/Built-In Memory	6	Number of remaining shots
3	Battery Status	7	Image Size
4	White Balance	8	Video Quality

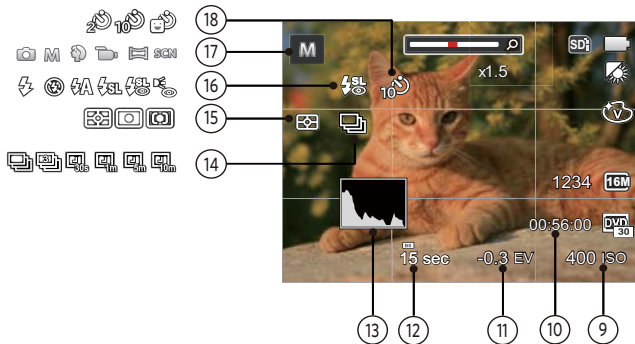

9	ISO Value	14	Continuous Shot
10	Remaining Recording time	15	Expo Metering
11	Exposure Compensation (EV value)	16	Flash Mode
12	Shutter Speed	17	Shooting Mode
13	Histogram	18	Self-Timer



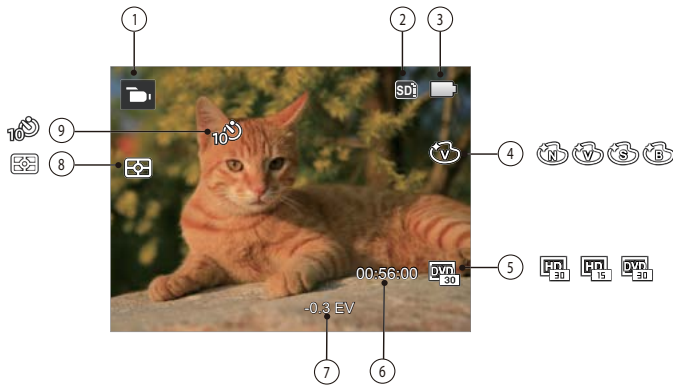



Overview of the Screen Icons in Movie Mode



1	Movie Mode	6	Remaining Recording time
2	Memory Card/ Built-In Memory	7	Exposure Compensation (EV value)
3	Battery Status	8	Expo Metering
4	Color Effect	9	Self-Timer
5	Video Quality		

Using the Mode Button



Press the Mode button to change different shooting modes. Available modes are listed below:

Mode Name	Icon	Description
Auto Mode		In this mode, the optimal conditions for taking pictures will be set based on the subject and environment. It is the most commonly used mode for taking pictures.
Manual Mode		Many of the camera settings can be configured manually in this mode.
Portrait Mode		The best setting for portrait shooting, enables AE/AF for faces.
Movie Mode		Record videos.
Panorama Mode		In this mode, up to 4 frames can be stitched together to create a single panoramic photo.
Scene Mode		Choose from 21 different pre-set scene types and effects for your photos.

Auto Mode



Auto Mode is the easiest mode to take photos. While operating in this mode, the camera automatically optimizes numerous camera settings to adjust your photos and videos for the best possible results.

Follow these steps:

1. Press the  button to select Auto Mode , and press the  button to confirm.
2. Press the shutter button to take a picture.

Manual Mode **M**

When selecting manual **M** mode, you can set the aperture / shutter speed manually and ISO value.

1. Press the  button to select Manual Exposure Mode **M**, and press the  button to confirm.

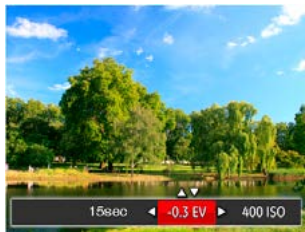

2. Press the left/right arrow button to select an adjustment setting.
3. Press the up/down button to adjust the parameters.
4. Press the  button to confirm the settings and enter the shooting screen.

Portrait Mode

In portrait mode, the camera is set to automatically adjust exposure for realistic capture of skin tones.

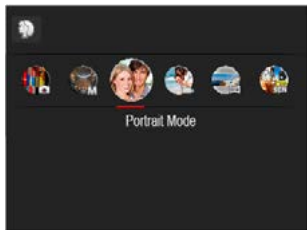



Press the mode button to select portrait mode ().

Panorama Mode

With Panorama Mode, you can take a series of pictures which will be stitched automatically into a ultra-wide panoramic picture by the camera.

Follow these easy steps to create a panoramic picture:

1. Press the  button to select Panorama Mode , and press the  button to confirm.
2. Press the arrow buttons to select a shooting direction. (The right direction is used as default if you do not make any choice) 2 seconds later, the camera is ready to take pictures.
3. Compose the first view of the panoramic picture on the LCD screen and press the Shutter button to capture the image.
4. After the first shot is taken, the semi-transparent image of the first shot will appear at the edge of the screen. You can use this image to compose your picture before you press the Shutter button to capture and finish manual stitching.

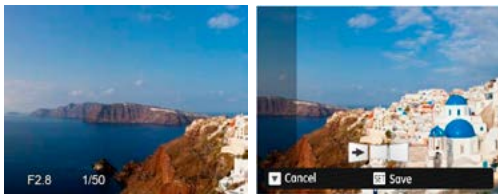











5. If continuous pictures are less than 4 shots, press **(SET)** button, the camera will splice the pictures automatically. Press playback button to enter playback mode to see the effect.
6. If you take 4 pictures, the camera will splice the pictures automatically. Press playback button to enter playback mode to see the effect.













- After selecting Panorama Mode, Flash, Self-timer and Exposure Compensation cannot be adjusted.
- In Panorama Mode, up to 4 photos can be captured when the image size is set at 2MP.

Scene Mode SCN

You can select an appropriate mode from the 21 scene modes according to the type of environment you are shooting. The camera then configures the most appropriate settings automatically.

Press the  button to select "SCN" mode. Press the arrow buttons to select a scene, and press the  button to confirm.

Scene	Description
 Auto Scene	Identifies the scene automatically; Landscape Mode, Portrait Mode, Night Portrait, Backlit Portrait, Night Landscape Mode, Auto Mode
 Landscape	For landscapes and outdoor shots. Vivid reproduction of green and blue.
 Sport	For fast-moving subjects. Capture sharp, action shots with minimal blur. This mode is not recommended for shooting indoors.
 Beach	For taking pictures in areas with strong sunlight.
 Sunset	For sunsets. Capture subjects in strong sunlight.
 Fireworks	For fireworks at night. Slower shutter speed is adjusted for brilliant images. The use of a tripod is recommended.
 Night Landscape	For night scenes. The use of tripod is recommended.
 Snow	For snow scenes. Reproduce natural, clear white scenes.
 Children	Turns off flash automatically. Avoids disturbing subject, suitable for taking photos of children.







Scene	Description
 ID	For shooting ID size photos. (It is recommended to print using 6-inch 4R (6X4) photographic paper).
 Glass	For objects behind transparent glass.
 Photo Frame	For adding interesting frame effects to the photo.
 Panning Shot	Suitable for capturing fast moving objects to have a clear subject with a blurred background.
 Text	For taking pictures of text, documents or white boards.
 Fish Eye	For interesting fish eye effect.
 Party	Suitable for taking indoor party pictures, even under the complicated lighting conditions.
 Indoor	For indoor settings. Reduce blur and improve color accuracy.
 Leaf	For plants. Capture brilliant shots of greenery and blossoms.
 Museum	For museums or flash-free areas. Retain color and reduce blur.
 Night Portrait	For portraits against night scenery.
 Sketch	For taking photos with pencil sketch effect.

Auto Scene Mode (ASCN)

In **ASCN** scene mode, the camera can detect different environments intelligently and automatically select the best scene and photo settings for you.

1. Press the **MODE** button to select “SCN” mode, then select **ASCN** function.
2. Hold the camera steadily and aim at the subject. The optimum scene mode will be selected automatically.
3. Press the shutter button to take a picture.



Mode Name	Description
 Landscape Mode	For landscapes, ASCN will automatically adjust the exposure and reproduce vivid green and blue colors.
 Portrait Mode	Most suitable for capturing people with focus on their faces.
 Night Portrait	When you take portraits at night, or in low light conditions, ASCN will automatically adjust the exposure for people and night scenes.
 Backlit Portrait	When the sun or any other light source is behind you, ASCN will automatically adjust the foreground exposure to produce the best pictures possible.
 Night Landscape Mode	For night scenes, ASCN will automatically increase the ISO value to compensate for low light.
 Auto Mode	The camera will automatically adjust the exposure and focus to ensure the best possible pictures.

BASIC OPERATION

Display Setting

Press the **DISP.** button to display the settings: Classic, Full, Off.

Classic: Displays the camera parameters on screen

Off: Does not display any additional icons on screen

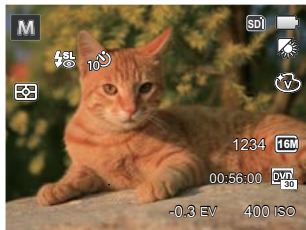

Full: Camera parameters with Grid and Histogram

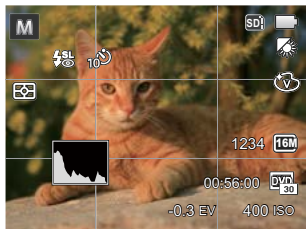



Self-Timer Setting



Use this function to take pictures at pre-set intervals. The camera shutter speed can be set for 2 seconds, 10 seconds or by smile detection.

1. Press the left arrow button () to enter the self-timer menu.



2. Press left/right to select the following 4 modes:

-  Self-timer Off
Disables the Self-Timer.
-  Self-timer 2 sec
A single picture is shot 2 seconds after the Shutter Button is pressed.

-  Self-timer 10 sec
A single picture is shot 10 seconds after the Shutter Button is pressed.
-  Self-timer Smile
Press the Shutter Button and a picture will be taken immediately after a smile is detected.

3. Press the  button to confirm the settings and exit the menu.



Flash Mode





The flash is mainly for supplementing light for the scene. The flash is usually used in shooting against the light to highlight the object shot through lightening the object while darkening the background; it is also suitable for metering and shooting in darker scenes through exposure.

1. Press the right arrow button () to enter the Flash Settings Menu.



2. Press the left/right to select the following 6 modes:

-  Force Off
Flash is turned off.
-  Flash Auto
Camera flash goes off automatically based on existing light conditions.

-  Force Flash
The flash will engage with each shot even if there is enough available light to take the photo without flash.
 -  Slow Sync.
This allows for night scenery photos that include people in the foreground. The use of a tripod is recommended when shooting with this setting.
 -  Slow Sync. + Red-Eye
Use this mode for slow synchro shots with red-eye reduction.
 -  Red-Eye Reduction
The camera emits a brief pre-flash before the picture is taken to reduce red-eye effects.
3. Press the  button to confirm the settings and exit the option.

EV Setting

The EV function menu of the camera includes functions, such as EV, shutter adjustment, ISO. Using the appropriate function settings can improve your pictures.



To select the best setting for optimum photos, follow these steps:

1. Press the **SET** button to display the settings screen.
2. Press the left/right arrow button to select the setting options.



3. Press the up/down button to adjust the option values.
4. Press **SET** button to complete the setting and enter shooting mode.

Exposure Compensation

Set up to adjust the picture brightness. In the case of a very high contrast between the photographed object and the background, the brightness of the picture can be appropriately adjusted. (Adjustable only in   Mode)

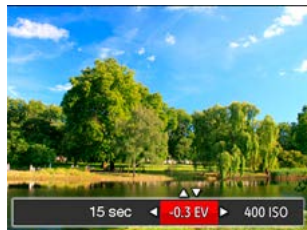

The adjustable range of exposure value is from EV -2.0 to EV+2.0.

ISO

The ISO function allows you to set the sensitivity of the camera's light sensor based on the brightness of the scene. To improve the camera's sensor performance in darker environments, a higher ISO value is required. A lower ISO value is needed when shooting in brighter conditions.

Pictures taken at higher ISO settings will generally have more noise than those taken at lower ISO settings. (Adjustable only in  Mode)

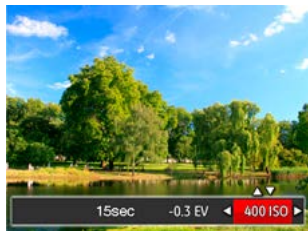

The camera's ISO settings include: Auto, 80, 100, 200, 400, 800, 1600.

Shutter Adjustment

For shutter speed, the camera may automatically set the aperture value corresponding to the manually set shutter speed so as to obtain a most suitable exposure value. The movement of object may be shown by adjusting the shutter speed. High shutter value can make you clearly capture the movement of fast moving object while low shutter value can allow you to take a picture for fact moving object with a strong sense of movement. (Adjustable only in  Mode)



Using Quick Recording

In shooting mode, press the Recording short cut button  to begin recording video.



After finishing, press the Recording short cut button or the Shutter Button to stop and store the video. The camera will return to shooting mode automatically.

PLAYBACK

Overview of the Screen Icons in Playback Mode

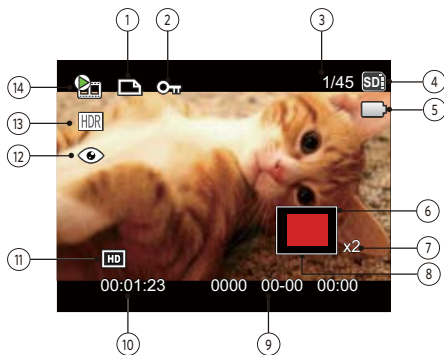

1	DPOF File	8	Image Zone
2	File Protection	9	Shooting Date
3	Memory space (indicating the current number of photos and total number of photos)	10	Film length
4	Memory Card/Built-in Memory	11	Video Quality
5	Battery Status	12	Red-Eye Reduction
6	Zoom Magnification Area	13	HDR
7	Image Zoom Ratios	14	Film file

Viewing Photos and Videos

To view the captured photos and video clips on the LCD screen:

1. After pressing the **(▶)** button, the last photo or video clip taken will be displayed on the LCD screen.
2. Use the Left/Right navigation buttons to scroll through the photos or video clips stored in the internal memory or on the memory card.
3. To play a selected video clip, press the **(SET)** button to enter the Movie Playback Mode.

An operation guide appears on the screen when playing back a video. Press the appropriate buttons to enable the corresponding functions.

Under Playback

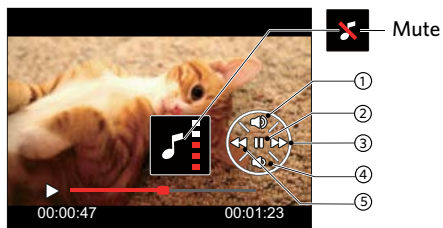

1	Increase Volume
2	Pause
3	Fast Forward
4	Decrease Volume
5	Rewind

Paused

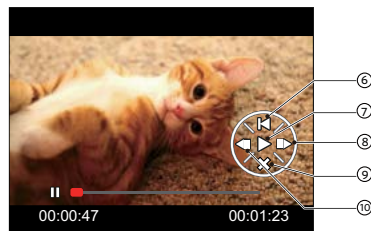

6	Back to the beginning of the video
7	Play
8	Play video forward
9	Cancel playback
10	Play video backward

Thumbnail View

When in playback mode, press **W** on the zoom button to display thumbnail images of photos and videos on the screen.

W Zoom

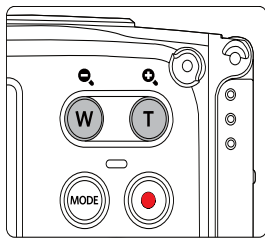

T Zoom In

1. Slide the zoom button to switch between 3x3 and 4x4 thumbnails.

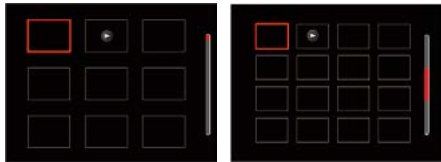



2. Press the arrow buttons to select a picture or video clip to view and press the **SET** button to restore it to the original size.





If the  indicator appears on the LCD, then a movie file is currently being displayed.

Using Zoom Playback (for still pictures only)

When playing back photos, you can also use the Zoom button to zoom in on the photos 2 to 8 times.

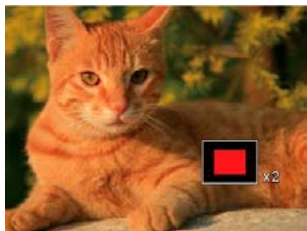
1. Press the  button to switch to Playback Mode.
2. Press the left/right button to select a picture to be zoomed in.
3. Press the  on the zoom button to zoom in.
4. The bottom right corner of the screen will display the number of times and area of the photo zooming operation.





5. Press the arrow buttons to navigate and select a part of the image to be zoomed in.
6. Press the  button to return the image to its original scale.



Movie images cannot be magnified.

Slideshow

This setting allows you to view all the stored pictures as a slideshow.

1. Press the  button to enter playback screen.
2. Press the  button to enter slide option.
3. Press the left/right button to select slideshow playing or [Cancel] to return to the playback screen.





4. Press the  button to confirm the setting.

Photos and Video Deletion

In playback mode, press the down arrow button  to select your photos and videos.

To delete photos or videos:

1. Press the  button to switch to playback mode.
2. Press the left/right arrow button to select the photos and videos to be deleted.
3. Press the down arrow button  and the deletion screen is displayed.



4. Press the up/down arrow button to select [Delete One] or [Exit] and press the  button to confirm.



Erased photos/video clips cannot be recovered.





Please refer to page 59 for instructions on deleting more than one image at a time.

USING THE MENUS

Photo Setup Menu

Mode:  **M**  **SCN**

1. In Photo Shooting Mode, press the  button to enter the Photo Shooting Menu.
2. Press the up/down arrow button to select the Photo Shooting Menu to be set.
3. Press the left/right arrow button to select the Photo Shooting Menu to be set and press the  button to confirm.

Refer to the following pages for more details about each setting.

Expo Metering (Exposure Metering)

Use this setting to select the "target" size of the camera's field of view to be metered.



There are 3 options:

- **AiAE (Artificial Intelligence AE)**
Automatically selects the central and peripheral metering, to calculate the reasonable value of metering by weighting.
- **Spot metering** targets a small area in the center of the camera's field of view.
- **Center metering** targets a slightly larger area in the center of the cameras field of view.

Image Size

The size setting refers to the image resolution in pixels. A higher image resolution allows you to print that image in larger sizes without degrading the image quality.



- 16M: High quality printing
- 14M-3:2: Full size printing
- 12M-16:9: Display
- 10M: Poster printing
- 5M: A3 printing
- 3M: A4 printing
- 2M-16:9: 4"x 6" printing
- VGA: E-Mail



The bigger the number of recorded pixels is, the better the image quality becomes. As the number of recorded pixels lessen, you will be able to record more images on a memory card.

Continuous Shot



Use this setting to perform continuous shooting. After entering this mode, you can shoot multiple images by continuously holding the shutter button down.



-  Time-Lapse 30sec
-  Time-Lapse 1min
-  Time-Lapse 5min
-  Time-Lapse 10min

 The flash is disabled in this mode in order to achieve quick succession of shots.



There are 7 options:

-  Single
-  Continuous Shot
-  3 Shots





White Balance Setting

The White Balance Setting allows you to adjust the color temperature for different lighting sources to ensure the most accurate color reproduction.



-  Incandescent
-  Underwater
-  Manual WB (Fully press the shutter button to detect the white balance value)

There are 8 options:

-  AWB
-  Daylight
-  Cloudy
-  Fluorescent
-  Fluorescent CWF

Color Effect

The Image Color Setting allows you to select different color effects.





1. Press the **(SET)** button to select the Image Color Setting Menu.



2. Press the left/right arrow button to select the Image Color Setting options.



There are 4 options:

-  Normal
-  Vivid
-  Sepia
-  Black and White

- Shooting menu in the shooting mode (○: Optional ×: Not optional)

















Options	Shooting Modes				
		M			SCN
	○	○	○	○	○
	○	○	○	×	○
	○	○	○	×	×
	×	○	×	×	×
	×	○	×	○	×
	×	×	×	○	×
	×	×	×	×	○

Photo Shooting Setting Menu

Mode:     

1. Press the  button in Photo Shooting Mode and press the up/down button to select .



2. Press the  button to enter the menu.
3. Press up/down arrow button to select , and press the  button or right arrow button to enter the menu.
4. Press the up/down arrow button to select the item to be set and press the  button or right arrow button to enter the menu.
5. Press the up/down arrow buttons to select an option and press the  button to confirm.

Quality

The Quality Setting can be used to adjust the image compression ratio.

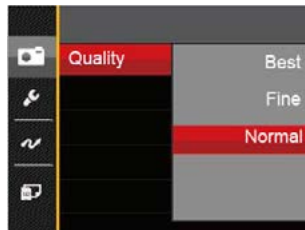

There are three options for picture quality:

- Best (16M Average File Size: 4.0MB)
- Fine (16M Average File Size: 2.5MB)
- Normal (16M Average File Size: 2.0MB)

Face Detection



For detecting on faces to make all faces as clear as possible in photo mode.

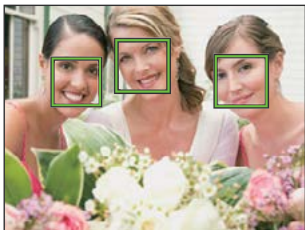

1. Hold the camera steadily and then focus on the object to detect its face. A detection frame will be shown on the face part on the screen once a human face is detected.



2. Press the shutter button to take a picture.

 The closed eyes detection is usually on. If the camera detects in the course of quick review there is a face with eyes closed, a prompt of closed eyes will appear .

Digital Zoom

Turn on or off the digital zoom.



Date Imprint

Include a Date/Time stamp on the photo image.



- Off
- Date
- Date / Time

Quick Review

This option allows quick review of the photos immediately after they are taken. Each photo is displayed on the LCD screen based on the selected time.



There are 4 options:

- Off
- 1 sec
- 2 sec
- 3 sec

Movie Menu

Mode: 

1. Press the **(MODE)** button, select the  mode and press the **(MENU)** button to enter the Movie Menu.
2. Press the up/down arrow button to select the Movie Menu to be set.
3. Press the left/right arrow button to select the Movie Menu to be set and press the **(SET)** button to confirm.

Expo Metering (Exposure Metering)

Use this setting to select the "target" size of the camera's field of view to be metered.



There are 3 options:

- **AiAE (Artificial Intelligence AE)**
Automatically selects the central and peripheral metering, to calculate the reasonable value of metering by weighting.
- **Spot metering** targets a small area in the center of the camera's field of view.
- **Center metering** targets a slightly larger area in the center of the cameras field of view.

Video Quality

Set the image resolution used during video recording.

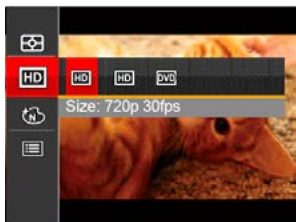

The speed requirements for reading and writing high image pixel images to memory card are as follows:

No.	Image Pixel	Frame	Recommendation	Recording time (4GB) About
1	1280x720 *	30	Class 6	16 minutes
2	1280x720	15	Class 6	32 minutes
3	640x480	30	Class 4	48 minutes



* The longest recording time is 29 minutes at one time.



When recording in higher pixel resolutions for extended periods of time, this can cause the camera to generate heat. This is not a camera malfunction.



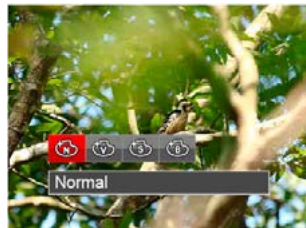

Color Effect

The Image Color Setting allows you to select different color effects.

1. Press the **(SET)** button to select the Image Color Setting Menu.
2. Press the left/right arrow button to select the Image Color Setting options.





There are 4 options:

-  Normal
-  Vivid
-  Sepia
-  Black and White

Movie Setting Menu

Mode: 

1. Press the **(MODE)** button, and select  to enter the video recording screen.
2. Press the **(MENU)** button, press the up/down arrow button to select , and press the **(SET)** button to enter the menu.

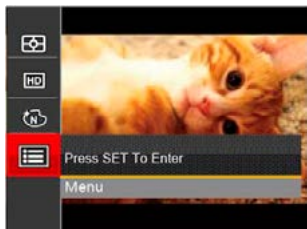

3. Press up/down arrow button to select , and press the **(SET)** button or right arrow button to enter the menu.
4. Select the items to be set and press the **(SET)** button or the right arrow button to enter the menu.
5. Press the up/down arrow buttons to select an option and press the **(SET)** button to confirm.





Digital Zoom

Turn off the digital zoom.



Playback Menu

Mode: 



1. Press the  button to display the playback screen and press  button to enter the menu.
2. Press the up/down arrow button to select the playback to be set and press  button to enter.
3. Press the left/right arrow buttons to select an option and press the  button to confirm.





Refer to the following pages for more details about each setting.

HDR

With the HDR function, pictures that are overexposed may be corrected to optimize the highlights and lowlights captured to more accurately represent the actual scene.

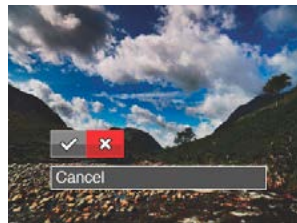
1. In Playback Mode, press the left /right arrow button to select the photos to be edited.
2. Press the  button, select the  settings, and press the  button to display the settings screen.
3. Press the left/right button to select whether HDR is used.





 : HDR

 : Cancel

4. After using the HDR function, the image will be saved as a new file and the original file is still stored in the memory.

Red-Eye Reduction

1. In Playback Mode, press the left /right arrow button to select the photos to be edited.
2. Press the  button, select the  settings, and press the  button to display the settings screen.
3. Press the left/right button to select the corresponding menu or [Cancel] to return to the playback screen.





 : Red-Eye Reduction

 : Cancel

4. Press the  button to confirm the setting.

Color Effect

This setting allows you to change the picture color effect. The file is saved as a new photo and stored in memory together with the original photo.

1. In Playback Mode, press the left /right arrow button to select the photos to be edited.
2. Press the  button, select the  settings, and press the  button to display the settings screen.
3. Press the left/right button to select the corresponding menu or [Cancel] to return to the playback screen.



 : Cancel

 : Vivid



 : Sepia

 : Black and White

4. Press the  button to confirm the setting.

Rotate

You can use this setting to change the orientation of the picture.



1. In Playback Mode, press the left /right arrow button to select the photos to be edited.
2. Press the  button, select the  settings, and press the  button to display the settings screen.
3. Press the left/right button to select the rotation direction or [Cancel] to return to the playback menu.



 : Turn Right



 : Turn Left

 : Cancel

4. Press the  button to confirm the setting.
 Videos and panoramic pictures cannot be rotated.
 The rotated picture file will replace the original photo.

Resize

This setting allows you to resize a picture to a particular resolution and saves it as a new picture.

1. In Playback Mode, press the left /right arrow button to select the photos to be edited.
2. Press the  button, select the  settings and press the  button to display the settings screen.
3. Press the left/right arrow button to select [1024] or [640] or select [Cancel] to return to the playback menu.



1024 : Resize to 1024x768





640 : Resize to 640x480

 : Cancel



4. Press the  button to confirm the setting.

Playback Setting Menu

Mode: 

1. Press the  button to show the playback screen, press the  button, and press the up/down button to select .
2. Press the  button to enter the menu.



3. Press up/down arrow button to select , and press the  button or right arrow button to enter the menu.
4. Press the up/down arrow button to select the item to be set and press the  button or right arrow button to enter the menu.

5. Press the up/down arrow buttons to select an option and press the  button to confirm.
Refer to the following pages for more details about each setting.

Protect

To prevent any pictures or videos from being accidentally erased, use this setting to lock one or all of the files.



To lock or unlock the photo and video files:

1. Press the up/down arrow button to select [Protect] and press the (SET) button or right arrow button to enter the sub-menu.
2. Press the up/down arrow button to select the submenu and press the (SET) button or right arrow button to show the settings screen.
There are 3 sub menus available:
 - One
Lock the selected photo or video if they are unprotected; unlock the selected photo or video if they are protected.
 - All
Lock all photos or videos.
 - Reset
Cancel all locked photos or videos.
3. Press the up/down arrow buttons to select an option and press the (SET) button to confirm.

Delete

You can delete one or all photo/video files.

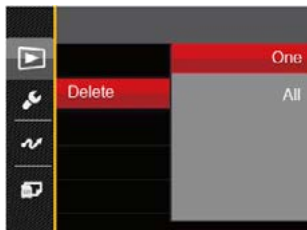



To delete photo or video files:

1. Press the up/down arrow button to select [Delete] and press the **SET** button or right arrow button to enter the submenu.
2. Press the up/down arrow button to select the submenu and press the **SET** button or right arrow button to show the settings screen.

There are 2 sub menus available:

- One
Delete one photo or video.
- All
Delete all photos or videos.

3. Press the up/down arrow buttons to select an option and press the **SET** button to confirm.

 The “” indicator means a file is protected. File protection must be removed first before a file can be deleted.

 Deleting files will cause DPOF settings to be reset.

DPOF (Digital Print Order Format)

The DPOF feature allows you to compile and select a group of pictures that you would like to print and will save your selection on the memory card so that you can use the memory card to print without having to individually specify the photos you want to print.



The printer that supports DPOF is needed for printing.

Trim

The Trim Setting allows you to crop photos and save them as new pictures.

1. Press the up/down arrow button to select [Trim] and press the **(SET)** button or right arrow button to enter the menu.
2. Select [Yes] to confirm trim. Select a part to be trimmed using the zoom button and arrow buttons to trim a photo.

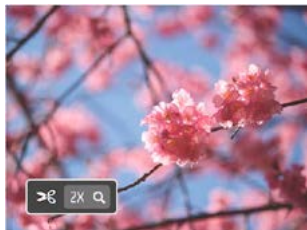







3. Press the **(SET)** button and the [Save change?] prompt appears. Select [] to change and save the picture. Select [] to cancel changes and return to the trim prompt screen.



The image cannot be clipped/trimmed again once it has been clipped to 640X480.

General Settings

Mode :       

1. Press the  button in any mode and press the up/down button to select .
2. Press the  button to enter the menu.
3. Press up/down arrow button to select , and press the  button or right arrow button to enter the menu.
4. Press the up/down arrow button to select the item to be set and press the  button or right arrow button to enter the menu.
5. Press the arrow buttons to select an option and press the  button to confirm.



Refer to the following pages for more details about each setting.

Sound Settings

To change this setting:

1. Select [Sound Settings] in the basic settings menu.
Press the **(SET)** button or right arrow button to enter the menu.
2. Press the left/right arrow button to select an option.



3. Press the **(SET)** button to confirm.

Power Saver

This setting allows you to save power and get the maximum possible running time for your camera's batteries. Follow the steps below to turn the LCD screen and camera off automatically after a consecutive period of inactivity.

1. Select [Power Saver] in the basic settings menu.
Press the **(SET)** button or right arrow button to enter the menu.
2. Press the up/down arrow button to select an option.



3. Press the **(SET)** button to confirm.



Power Saver	LCD power off time	Turn off time
Auto	3 min	5 min
Normal	1 min	3 min
Best	30 s	1 min

Language

Refer to the “Reset your language” section on page 18.

Zone

The Zone setting is a useful function for your overseas trips. This feature enables you to display the local time on the LCD screen while you are abroad.

1. Select [World Time] in the basic settings menu.
The World Time screen appears.
2. Press the up/down to select the departure place () and destination () fields.
3. Press the left/right arrow button to select a city located in the same time zone as that of the field.
Press the  button to confirm settings.



Date/Time







Refer to the “Reset Date/Time” section on page 19.

File Settings

Format Memory

Please note: formatting enables you to delete all contents in the memory card and built-in memory, including protected photo and movie files.

To use this setting:

1. Press the  button, press the up/down arrow button to select  and press the  button to enter the menu.
2. Press up/down arrow button to select  and press the  button or right arrow button to enter the menu.
3. Press the up/down arrow button to select [Format] and press the  button or right arrow button to enter the menu.
4. Press the up/down arrow buttons to select [Yes] or [No] and press the  button to confirm.









5. If you select [Yes] the camera formats its memory.

 If there is no memory card in the camera, the built-in memory will be formatted; if there is a memory card, it will be formatted only.

Copy to Card

Use this setting to copy the files stored in the internal memory to an memory card.







1. Press the  button, press the up/down arrow button to select  and press the  button to enter the menu.
2. Press up/down arrow button to select  and press the  button or right arrow button to enter the menu.
3. Press the up/down arrow button to select [Copy to Card] and press the  button or right arrow button to enter the menu.
4. Press the up/down arrow buttons to select [Yes] or [No] and press the  button to confirm.



If there is no card available in the camera, this function will not be displayed.

File Numbering







After you take a picture or video clip, the camera will save it with a sequential number. You can use this to reset the file numbering to 0001.

1. Press the  button, press the up/down arrow button to select  and press the  button to enter the menu.
2. Press up/down arrow button to select  and press the  button or right arrow button to enter the menu.
3. Press the up/down arrow button to select [File Numbering] and press the  button or right arrow button to enter the menu.
4. Press the up/down arrow buttons to select [Yes] or [No] and press the  button to confirm.



Reset





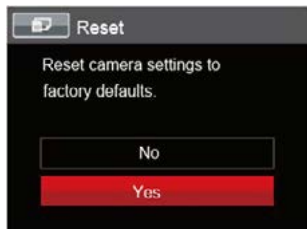

Use this setting to restore the camera to its original factory default settings.

1. Press the  button, press the up/down arrow button to select  and press the  button to enter the menu.
2. Press up/down arrow button to select  and press the  button or right arrow button to enter the menu.
3. Press the up/down arrow button to select [Reset] and press the  button or right arrow button to enter the menu.
4. Press the up/down arrow buttons to select [Yes] or [No] and press the  button to confirm.



FW Version

Use this setting to view the current camera firmware version.

1. Press the  button, press the up/down arrow button to select  and press the  button to enter the menu.
2. Press up/down arrow button to select  and press the  button or right arrow button to enter the menu.
3. Press the up/down arrow button to select [FW Version] and press the  button or right arrow button to enter the menu.
4. When there is a new firmware version in the memory card, select [Yes] to update.









Connecting to a Computer

You can use a micro USB cable to connect the camera and copy (transmit) photos to a computer, printer or other device.

Setting the USB Mode

The camera's USB port can be set to connect with either a computer or a printer. The following steps will allow you to ensure that the camera is correctly configured to connect with a PC.

1. Press the  button, press the up/down arrow button to select  and press the  button to enter the menu.
2. Press up/down arrow button to select  and press the  button or right arrow button to enter the menu.
3. Press the up/down arrow button to select 「USB」 and press the  button or right arrow button to enter the menu.
4. Press the up/down arrow buttons to select 「PC」 and press the  button to confirm.



Transferring files to your computer

The computer will automatically detect the camera as a removable drive. Double-click the My Computer icon on the desktop to locate the removable drive and to copy folders and files in the drive to a directory on your PC as you would copy any typical folder or file.





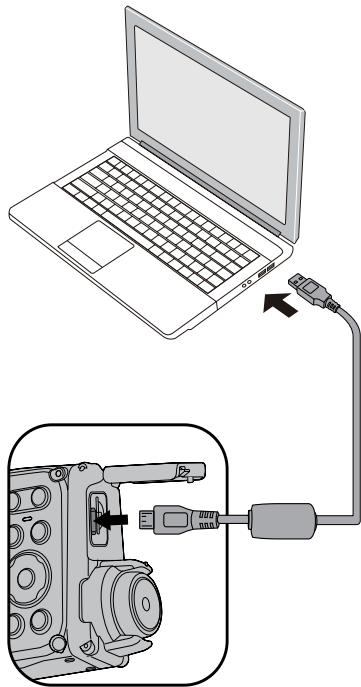

Follow the steps below to connect the camera to a computer.

1. Make sure both the camera and computer are turned on.
2. Connect one end of the supplied micro USB cable to the USB/AV OUT port on your camera.
3. Connect the other end of the micro USB cable to an available USB port on your computer.
4. After the transmission is complete, disconnect the micro USB cable according to the instructions specifying how to safely remove USB devices.

Video System



You can use the AV cable (which should be purchased separately) to connect the camera and the television for realizing the video output. Connect one end of the AV cable to AV port of the camera, connect the other end to AV-OUT port of the television. Adjust the format of the video output system according to your requirements, and the steps are as follows:

1. Press the  button, press the up/down arrow button to select  and press the  button to enter the menu.
2. Press up/down arrow button to select  and press the  button or right arrow button to enter the menu.
3. Press the up/down arrow button to select [TV-System] and press the  button or right arrow button to enter the menu.
4. Press the up/down arrow buttons to select [NTSC] or [PAL] and press the  button to confirm.









The video output system would change accordingly based upon the changes of the selected language.

NTSC: English, Chinese (Traditional), Japanese, French, Korean, Russian, Vietnamese, Greek, Hungarian

PAL: German, Spanish, Italian, Chinese (Simplified), Portuguese, Swedish, Danish, Finnish, Indonesia, Norwegian, Dutch, Turkish, Polish, Thai, Croatian, Czech, Arabic, Hindi

Battery Type

Please choose the right type of battery before using.

1. Press the  button, press the up/down arrow button to select  and press the  button to enter the menu.
2. Press up/down arrow button to select  and press the  button or right arrow button to enter the menu.
3. Press the up/down arrow button to select [BATTERY TYPE] and press the  button or right arrow button to enter the menu.
4. Press the up/down arrow buttons to select [ALKALINE] or [NI-MH] and press the  button to confirm.

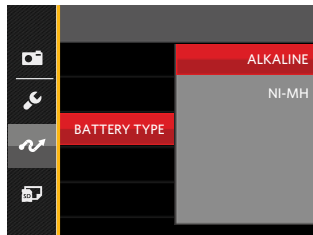

Connecting to a PictBridge Compatible Printer









PictBridge technology allows printing of the photos saved in the memory card by the printer.

To find out if a printer is PictBridge compatible, simply look for the PictBridge logo on the packaging or check the owner's manual for specifications. With the PictBridge function on your camera, you can print the captured photos directly to a PictBridge compatible printer using the supplied micro USB cable, without the need for a PC.

Setting the USB Mode

The camera's USB port can be set to connect with either a PC or a Printer, the following steps will ensure that the camera is correctly configured to connect with a Printer.

1. Press the  button, press the up/down arrow button to select  and press the  button to enter the menu.
2. Press up/down arrow button to select  and press the  button or right arrow button to enter the menu.
3. Press the up/down arrow button to select [USB] and press the  button or right arrow button to enter the menu.
4. Press the up/down arrow buttons to select [Printer] and press the  button to confirm.



 After the camera is reset, it will switch to PC mode automatically from USB mode.

 See "PictBridge" section on page 72.

Connecting to your Printer

1. Make sure both the camera and printer are turned on.
2. Connect one end of the supplied micro USB cable to the USB port on your camera.
3. Connect the other end of the micro USB cable to the USB port on the printer.

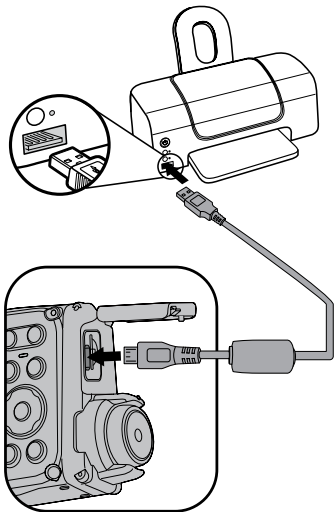

If the camera is not connected to a PictBridge compatible printer, the following error message will appear on the LCD screen.

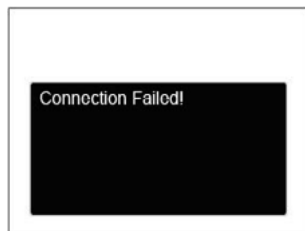

-  The error message above will also appear if the USB mode is set incorrectly, in which case you should disconnect the micro USB cable, check the USB mode settings, ensure that the Printer is turned on, and then try connecting the micro USB cable again.

Using the PictBridge Menu

After setting the USB mode to Printer, the PictBridge Menu will appear.



Press the up/down arrow button to select a menu item and press the **SET** button or right arrow button to enter the item.

Refer to the following sections for more detailed information on each setting.

Print (with Date)

If you have set the date and time on your camera, the date and time will be recorded and saved with each photo you take.

1. In the PictBridge menu, select [Print (with Date)] and the screen as shown below appears.



2. Press the left/right arrow button to select a photo to be printed.

3. Press the up/down arrow button to select the number of copies for the currently displayed photo.
4. Press the **SET** button and the following screen will appear.



5. Select [Yes] and press the **SET** button to confirm; select [Cancel] to cancel printing.

Print (without Date)

Use this setting to print the photos without dates on them.

1. In the PictBridge menu, select [Print (without Date)] and the screen as shown below appears.



2. Press the left/right arrow button to select a photo to be printed.
3. Press the up/down arrow button to select the number of copies for the currently displayed photo.
4. Press the **SET** button and the following screen will appear.



5. Select [Yes] and press the **(SET)** button to confirm; select [Cancel] to cancel printing.

Print Index

You can print all photos in the camera via this function.

1. In the PictBridge menu, select [Print Index] and the screen as shown below appears.



2. Select [Yes] and press the **(SET)** button to confirm; select [Cancel] to cancel printing.

Print DPOF Images

To use DPOF printing, you must select your photos for printing using the DPOF settings beforehand. See “DPOF” section on page 60.

1. In the PictBridge menu, select [Print DPOF Images] and the screen as shown below appears.



2. Select [Yes] and press the **SET** button to confirm; select [Cancel] to cancel printing.

Exit

Select [Exit] to exit the PictBridge menu. At this time, the message [Remove USB Cable!] appears on the screen.

Disconnect the micro USB cable from the camera and printer.

APPENDICES

Specifications



Design and specifications are subject to change without notice.

Effective Imaging Sensor Pixels		16.15 Megapixels		
Total Image Sensor Pixels		16.44 Megapixels [1/2.3"CCD]		
Lens	Focal Length	5.53mm		
	35mm film equivalent	31.5mm		
	F number	F2.85		
	Lens Construction	5 elements		
	Optical Zoom	Fixed focus		
	Focusing Range	60cm - ∞		
Digital Zoom		2x Digital Zoom		
Number of Recording Pixels	Still Image	(4:3) 16MP: 4608×3456 10MP: 3648×2736 5MP: 2592×1944 3MP: 2048×1536 0.3MP: 640×480	(3:2) 14MP: 4608×3072	(16:9) 12MP: 4608×2592 2MP: 1920×1080
	Movie	1280×720: 30fps/15fps, 640×480: 30fps		

Image Compression		Best, Fine, Normal
DCF, DPOF (Ver1.1) Support		Yes
File Format	Still Image	Exif 2.3 (JPEG)
	Movie	MOV [Image: Motion JPEG ; Audio: G.711 (Monaural)]
Shooting Modes		Auto Mode, Manual Mode, Portrait Mode, Movie Mode, Panorama Mode, Scene Mode
Scene Mode		Auto Scene, Landscape, Sport, Beach, Sunset, Fireworks, Night Landscape, Snow, Children, ID, Glass, Photo Frame, Panning Shot, Text, Fish Eye, Party, Indoor, Leaf, Museum, Night Portrait, Sketch
Detection Features		Face, Smile, Blink
Waterproof		Up to 5m
Shockproof		Up to 1.2m
Dustproof		Equivalent to JIS/IEC (IP6X)
Red-Eye Removal		Yes
HDR		Yes (Post-Processing)

Stitch Panorama	0°- 180° (Horizontal)	
LCD Display	2.7inch (230k Pixels)	
ISO Sensitivity	Auto, ISO 80/100/200/400/800/1600	
Exposure Metering Method	Artificial Intelligence AE (AiAE), Center-Weighted Average, Spot (Fixed to Center of Frame), Face AE	
Exposure Control Method	Program AE	
Exposure Compensation	±2EV in 1/3 Step Increments	
Shutter Speed	1/2000 ~ 4 Seconds (Manual: 30 Seconds)	
Continuous Shooting	Yes	
Playback Modes	Single, Index (9/16 Thumbnails), Slide Show, Zoom (Approx. ×2 ~ ×8)	
White Balance Control	AWB, Daylight, Cloudy, Fluorescent, Fluorescent CWF, Incandescent, Underwater, Manual WB	
Flash	Flash Method	Internal
	Flash Modes	Force Off, Flash Auto, Force Flash, Slow Sync., Slow Sync. + Red-Eye, Red-Eye Reduction
	Shooting Range	0.3m ~ 5.1m (ISO800)

Recording Media	Internal Memory: Approx. 8MB
	microSD/microSDHC Card (Up to 32GB Support) [MMC Card Not Supported]
PictBridge, ExifPrint Support	Yes
Jacks	AV-OUT/USB 2.0 (Micro 5 pin USB)
Power	AA Alkaline Battery(×2) AA Ni-MH Battery(×2) (Not Included)
Shooting Capability (Battery Performance)	Approx. 190Shots of AA Alkaline Battery (Based on CIPA Standards)
Operation Environment	Temperature: 0 ~ 40°C, Humidity: 0 ~ 90%
Dimensions (W×H×D)	Approx. 107.1×59.8×28.0mm (Based on CIPA Standards)
Weight	Approx. 130g (Body Only)

Prompts and Warning Messages

Message	Description	Action
Warning! Battery exhausted.	Warning before power off when the camera battery is exhausted.	Displaying that it will power off after 2 seconds.
Suggest using tripod.	When continuous exposure is enabled, this prompt messages is display when the photo shooting screen is displayed for the first time.	It disappears after 2 seconds.
Built-in memory error!	In the case of built-in memory error.	It disappears after 2 seconds.
Slow shutter is on: may easily cause overexposure.	When the B shutter is on, the prompt appears on the screen after you go back to the photo shooting screen.	It disappears after 2 seconds.
Connection Failed!	Failure to connect to your PC, printer, TV.	The message disappears by removing the USB cable to stop connection.

Message	Description	Action
Warning! Do not turn off your camera during update!	Appears during upgrade of firmware.	The message disappears after the camera update and shutdown.
Card Full !	In the case that the camera detects the card capacity is insufficient when turning on or pressing the shutter.	It disappears after 2 seconds.
Memory Full !	In the case that the camera detects the memory capacity is insufficient when turning on or pressing the shutter.	It disappears after 2 seconds.
Card Error !	The card cannot be recognized after being formatted.	Normal display.
Card is not formatted.	When the card reading error occurs, the message of not formatted will be displayed.	It disappears 2 seconds later and the Format screen is shown.
Slow access	When a card lower than Class 4 is recording movie above HD, it may be accessed slowly and the recording cannot be continued. The operation image may appear after 2 seconds (it may need to wait up to 9 seconds for the built-in memory).	The message disappears 2 seconds later to return to the photo shooting screen.

Message	Description	Action
No Red-Eye Detected!	No red-eye detected when pressing for red-eye removing in playback touch-up.	It disappears after 2 seconds.
This image cannot be edited.	The file format does not support editing or the editing file cannot be edit again.	It disappears after 2 seconds.
Exceeded maximum folder number.	Prompt message when the archives or file folders in memory card have reached the maximum (9999 for archives, 999 for file folder).	The message disappears after the operations are finished.
Too many pictures for fast processing.	During the playback by date, the images exceed specifications so that it is not possible to play by date.	The message disappears after 2 seconds and the camera returns to the normal playback mode.
Unable to recognize files.	When the format of the file viewed is not supported or the file is damaged and cannot be recognized properly.	This image message disappears only after the file is deleted.
No Picture!	When you press the play button, no image files exist in the camera or memory card.	The message disappears 2 seconds later to return to the photo shooting screen.
Protected! Undeletable!	The file is protected. The message appears when you delete it.	It disappears after 2 seconds.

Troubleshooting

Problem	Possible causes	Solution
Camera does not turn on	<ul style="list-style-type: none">■ The battery has been depleted.■ The battery is not inserted correctly.	<ul style="list-style-type: none">■ Recharge the battery.■ Correctly reinstall the battery.
Camera turns off suddenly during operation	<ul style="list-style-type: none">■ The batteries have been depleted.	<ul style="list-style-type: none">■ Recharge the battery.
Images and video files cannot be saved	<ul style="list-style-type: none">■ The memory card is full.	<ul style="list-style-type: none">■ Use another memory card or delete unnecessary files.
Images will not print from the connected printer	<ul style="list-style-type: none">■ The camera is not connected to the printer correctly.■ The printer is not PictBridge compatible.■ The printer is out of paper or ink.■ The printer paper is jammed.	<ul style="list-style-type: none">■ Check the connection between the camera and printer.■ Use a PictBridge compatible printer.■ Load paper into the printer or replace the ink cartridge in the printer.■ Remove the jammed paper.

Problem	Possible Causes	Solution
Saving data to memory card is slow	■ Using a memory card below Class 4 may result in slower recording times.	■ Use an memory card with write Class higher than 4 to improve performance.
Too many movies to process	■ The number of pictures or folders in the memory card exceed the specifications, so the playback can not be displayed.	■ Delete unwanted files.



The Kodak trademark and trade dress are used under license from Kodak.

© 2014 JK Imaging Ltd. All Rights Reserved.

JK Imaging Ltd., 17239 So. Main Street, Gardena, CA 90248 USA

JK Imaging Europe, 71 Clarendon Road, Watford, WD17 1DS, UK

<http://kodakpixpro.com>