

# KODAK PIXPRO SP360 4K

ACTION CAM

## User Manual



# ***Before You Start***

---

## **Declaration of Conformity**



Responsible Party: JK Imaging Ltd.

Address: JK Imaging Ltd., 17239 So. Main Street, Gardena, CA 90248 USA

Company Website: kodakpixpro.com

## **About this Manual**

Thank you for purchasing this product. Please read this manual carefully and keep it in a safe place for future reference.

- JK Imaging Ltd. reserves all rights of this document. No part of this published manual may be reproduced, transmitted, transcribed, stored in a retrieval system or translated into any language or computer language, in any form, by any means, without the prior written permission of JK Imaging Ltd.
- All trademarks mentioned in this manual are used for identification purposes only and are properties of their respective owners.
- This manual provides you with instructions on how to use your new KODAK PIXPRO Action Cam. Every effort has been made to ensure that the contents of this manual are accurate; however JK Imaging Ltd. reserves the right to make changes without notice.
- Throughout this manual,  indicates the useful information, " Page number" indicates an introduction to the contents on this page.

## **For Customers in the U.S.A.**

### Federal Communication Commission Interference Statement

This device complies with Part 15 of the FCC Rules. Operation is subject to the following two conditions: (1) This device may not cause harmful interference, and (2) this device must accept any interference received, including interference that may cause undesired operation.

This equipment has been tested and found to comply with the limits for a Class B digital device, pursuant to Part 15 of the FCC Rules. These limits are designed to provide reasonable protection against harmful interference in a residential installation. This equipment generates, uses and can radiate radio frequency energy and, if not installed and used in accordance with the instructions, may cause harmful interference to radio communications. However, there is no guarantee that interference will not occur in a particular installation. If this equipment does cause harmful interference to radio or television reception, which can be determined by turning the equipment off and on, the user is encouraged to try to correct the interference by one of the following measures:

- Reorient or relocate the receiving antenna.
- Increase the separation between the equipment and receiver.
- Connect the equipment into an outlet on a circuit different from that to which the receiver is connected.
- Consult the dealer or an experienced radio/TV technician for help.

FCC Caution: Any changes or modifications not expressly approved by the party responsible for compliance could void the user's authority to operate this equipment.

This transmitter must not be co-located or operating in conjunction with any other antenna or transmitter.

### Radiation Exposure Statement:

This product complies with the FCC portable RF exposure limit set forth for an uncontrolled environment and is safe for intended operation as described in this manual. Additional RF exposure reduction can be achieved if the product can be kept as far as possible from the user body or set the device to lower output power if such function is available.

### FOR COUNTRY CODE SELECTION USAGE (WLAN DEVICES)

Note: The country code selection is for non-US model only and is not available to all US model. Per FCC regulation, all WiFi product marketed in US must fixed to US operation channels only.

## **INDUSTRY CANADA**

This device complies with RSS-247/210 of the Industry Canada Rules. Operation is subject to the following two conditions: (1) This device may not cause harmful interference, and (2) this device must accept any interference received, including interference that may cause undesired operation.

### Radiation Exposure Statement:

The product comply with the Canada portable RF exposure limit set forth for an uncontrolled environment and are safe for intended operation as described in this manual. The further RF exposure reduction can be achieved if the product can be kept as far as possible from the user body or set the device to lower output power if such function is available.

## **NEW CAMERA OWNER / IMPORTANT INFORMATION**

Thank you for purchasing your new **KODAK PIXPRO SP360\_4K VR** camera. In an effort to provide you with the most up to date benefits and features of the SP360 4K, **we strongly encourage you to register your new camera on our website:**

**<https://kodakpixpro.com/support/product-registration>**

Doing so will keep you informed of important updates, including firmware, features and other important information that pertain to the SP360 4K. Your information is always kept secure, is encrypted and is never sold, shared or used for any purposes other than for SP360 4K camera specific notifications, unless you opt-in to receive other types of communications during the registration process.

## For Customers in Europe



This symbol [crossed-out wheel bin WEEE Annex IV] indicates separate collection of electrical waste and electronic equipment in the European countries. Please do not throw the equipment into domestic refuse. Please use the return and collection systems available in your country for proper, safe disposal of this product.

“CE” mark indicates that this product complies with the European requirements for safety, health, environment and customer protection. “CE” marked cameras are intended for sales in Europe.

Europe – EU Declaration of Conformity

This device complies with the essential requirements of the Directive 2014/53/EU. The following test methods have been applied in order to prove presumption of conformity with the essential requirements of the Directive 2014/53/EU:

The frequency and maximum transmitted power in EU are listed as below: 2412MHz-2462MHz (Wi-Fi 2.4GHz) : 6.03dBm

- EN60950-1/A12:2011+A2:2013

Safety of Information Technology Equipment

- EN 50566: 2013 + AC: 2014

Product standard to demonstrate compliance of radio frequency fields from handheld and body-mounted wireless communication devices used by the general public (30 MHz — 6 GHz)

- EN 62209-2:2010

Human exposure to radio frequency fields from handheld and body mounted wireless communication devices — Human models, instrumentation, and procedures

Part 2: Procedure to determine the specific absorption rate (SAR) for wireless communication devices used in close proximity to the human body (frequency range of 30 MHz to 6 GHz)

- EN 62479:2010

Assessment of the compliance of low power electronic and electrical equipment with the basic restrictions related to human exposure to electromagnetic fields (10 MHz to 300 GHz)

- EN 300 328 V2.1.1 (2016-11)

Wideband transmission systems; Data transmission equipment operating in the 2,4 GHz ISM band and using wide band modulation techniques

- EN 300 330 V2.1.1 (2017-02)

Short Range Devices (SRD); Radio equipment in the frequency range 9 kHz to 25 MHz and inductive loop systems in the frequency range 9 kHz to 30 MHz

- Draft EN 301 489-1 V2.2.0 (2017-03)

ElectroMagnetic Compatibility (EMC) standard for radio equipment and services; Part 1: Common technical requirements

- EN 301 489-3 V2.1.1 (2017-03)

Electromagnetic compatibility and Radio spectrum Matters (ERM); ElectroMagnetic Compatibility (EMC) standard for radio equipment and services; Part 3: Specific conditions for Short-Range Devices (SRD) operating on frequencies between 9 kHz and 246 GHz

- Draft EN 301 489-17 V3.2.0 (2017-03)  
ElectroMagnetic Compatibility (EMC) standard for radio equipment and services; Part 17: Specific conditions for Broadband Data Transmission Systems.

Hereby, [Sintai Optical (Shenzhen) Co., Ltd], declares that these [Action Cam and Remote] are in compliance with the essential requirements and other relevant provisions of Directive 2014/53/EU.

Manufacturer: Sintai Optical (Shenzhen) Co., Ltd

Address: Qiwei Ind Sec, 1st, 2nd,& 3RD Bldg, Lisonglang Village, Gongming Town, Bao'an District, Shenzhen, Guangdong, China



Packaging: Please follow local regulations for the recycling of packaging.

Batteries: Please dispose of used batteries at designated collection centers.

### **WARNING**

Altering, tampering or modifying the any parts of SP360 4K camera are unauthorized and will void the manufacturer's warranty and "could" void Federal and/or State Compliance.

### **Trademark Information**

The terms HDMI, HDMI High-Definition Multimedia Interface, HDMI Trade dress and the HDMI Logos are trademarks or registered trademarks of HDMI Licensing Administrator, Inc.



# Safety Notes

---

## **Product Notes:**

- Do not disassemble or attempt to repair the product by yourself.
- Do handle the product properly. This product may be damaged if dropped, punctured or crushed.
- Avoid directly touching the lens element, please use professional lens cleaning paper together with lens cleaning agents to wipe the lens and keep the lens clean.
- Do not use corrosive, alcoholic or organic-solvent-containing cleaners to wipe this product.
- Do not use or store this product in high temperature environment.
- Do not expose the lens to strong light sources (e.g. daylight, etc.) for extended periods.
- Do not use or store the product in a strong magnetic field environment.
- If the product is quickly transferred from a low temperature environment to a high temperature environment, water condensation may occur in the product due to physical changes. In this case, it is recommended to wait until the product returns to room temperature before you turn it on.
- If a photo or video cannot be played back due to improper operation by the user, the Company shall assume no liability or responsibility for compensation.
- Store the product in a dry and clean environment when you are going to store the product for a long period.
- According to the characteristics of the electronic elements of the camera, the temperature of the camera will rise (heat is emitted) in the use process. Even though the temperature is relatively high when heat is emitted from the surface of the camera, the camera is capable of shooting continuously without faults. When the camera detects that the temperature of the body is within certain temperature limitation, it will power off automatically.
- In case of power off due to the temperature limitation, the camera can be activated for shooting again after its temperature drops.

## **Battery Notes:**

- Please use a battery that is the same type as the one included.
- If the battery overheats during charging or use, stop charging or use immediately. Turn off the product, remove the battery carefully, and wait until it cools down.
- Please keep the battery contacts clean and dry.
- Please install the battery according to the positive and negative markings on the battery compartment. Never force it into the battery compartment.
- If battery fluid leaks into the product, please contact your retailer. If battery fluid leaks onto your skin, rinse your skin immediately with clean water and seek for medical attention.
- To prevent the battery from being damaged, do not drop the battery, hit it with heavy objects or scratch it with sharp objects.
- Do not let the battery be in contact with metal objects (including coins) in order to avoid short-circuiting, discharging, excessive heating, or possible leakage.
- Do not heat the battery or throw it into a fire in order to avoid a possible explosion.
- Remove the battery if it will be stored for a long period.
- Do not store the battery in high temperature environment.
- Using the battery in cold environment will result in a much lower performance.
- Do not attempt to disassemble the battery by yourself.
- Please dispose the battery properly according to local laws and regulations (national or regional).

### **Memory Card Notes:**

- The memory card referred to in this manual is a microSD card, microSDHC card or microSDXC card.
- Please keep the memory card clean and dry.
- When inserting a memory card, make sure the notch direction of the card matches the notch direction of the memory card mark near the card slot. Do not force the memory card into the card slot.
- Before using a brand new memory card, please format the memory card first.
- A photo or video taken with the product will be stored in the folder that is automatically generated on the memory card. Do not store photos or videos that were not taken using the product in these folders in case the files cannot be normally recognized in playback.
- Directly editing the data on the memory card is not recommended. Copy the data to your computer disk before editing is recommended.
- Please turn the product off before removing the memory card. Otherwise, the memory card could be damaged.
- When the product is stored for a long period, please backup the data on the memory card and remove the memory card.

### **Other Notes:**







- Do not disconnect the power or turn the product off during firmware updating process. Doing so may cause incorrect data to be written and the product may not power on later.
- When using your product on an airplane, observe the relevant rules specified by the airline.
- Due to the limitations of manufacturing technology, the LCD may have a few dead or bright pixels. These pixels do not affect the quality of the photos or videos.
- If the LCD screen is damaged, please pay close attention to the liquid crystal in the screen. If any of the following situations arise, kindly take the recommended actions immediately as indicated below:
  1. If liquid crystal comes in contact with your skin, please wipe your skin with a dry cloth, wash with soap thoroughly, and rinse with plenty of clean water.
  2. If liquid crystal gets into your eye, flush your eye with plenty of clean water immediately for at least 15 minutes. Please also seek for medical assistance.
  3. If liquid crystal is swallowed accidentally, immediately rinse your mouth with clean water and try to induce vomiting. Please also seek for medical assistance.

### **Waterproof Notes:**











- This product is splash proof for the purposes of daily activities. Before use, please make sure to lock the battery cover, and tightly close the side cover.
- Any scratches, cracks, or small foreign objects (such as sand or hair) attached to the rubber ring inside of the side cover will affect the efficacy of splash proof function. Before use, please check whether the waterproofing rubber is damaged or contaminated with a foreign object before closing the side cover. When there is a foreign object on the waterproofing rubber and its adjacent surfaces, please use a clean, lint-free dry cloth to clean it. If there are any scratches or cracks, immediately go to a service center for maintenance and obtain a replacement waterproofing rubber.
- Before using the product in water, please make sure you place it inside the waterproof housing first. It can be submerged to no more than 60 meters (196 feet) under the water at a temperature not exceeding 40 °C. The product can maintain its waterproof performance for up to 4 hours at a depth of 60 meters (196 feet) under water.
- Do not open the waterproof housing when submerged in water.
- Do not directly open the side cover or battery cover, when the product accidentally is exposed to water. Please turn off the power and wipe it with a clean, dry, lint-free cloth before opening the battery cover and side cover in order to remove the battery and the memory card.
- When opening the battery cover and the side cover, if there are water droplets on the surfaces located between the interior and the body, please make sure to wipe them off.
- After using the product in the presence of sand, mud or other foreign matter, please rinse it with clean water (please make sure to lock the battery cover, and close the side cover tightly before rinsing). After rinsing, wipe it with a clean, dry, lint-free cloth.

# Contents

---

Before You Start.....	1
Safety Notes .....	5
Contents .....	7
Getting Ready .....	9
Accessories Included .....	9
KODAK PIXPRO SP360 4K View .....	10
Mounting / Removing Lens Ring and Lens Cover .....	11
Installing Battery .....	12
Installing Memory Card .....	13
Charging the Battery .....	14
Configuration and Operation.....	16
Main Interface Introduction .....	16
Power On / Off .....	17
Start-up for language, date and time .....	17
Modes Introduction  .....	18
■ Movie mode  .....	18
■ Snap Shot Photo mode  .....	19
■ Loop recording mode  .....	19
■ Time-lapse movie mode  .....	19
■ High-speed movie mode  .....	20



■ Burst mode 	20
Introducing the Menu 	21
Every Shooting Mode Settings  /  /  /  /  / 	22
General Settings 	29
Remote Pair Setting  Remote Pair Setting	31
Remote Control	32
Using Interfacing	38
Micro USB interface	38
Charging	38
Using an external power supply	38
Data transmission	38
Webcam	40
Micro HDMI interface	42
Wi-Fi Mode 	44
Appendices	48
Specifications	48
Prompts and Warning Messages	51
Trouble Shooting	53
Special Accessories	54

# Getting Ready

## Accessories Included

Your product box should contain the product you purchased along with the following accessories. If anything is missing or appears to be damaged, please contact your retailer. (The AC Adapter style will vary according to the power requirement from different countries or regions. Below picture is for reference only)



Rechargeable Li-ion Battery

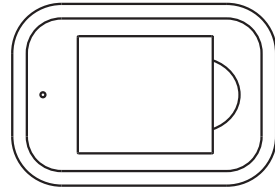

Battery Charger

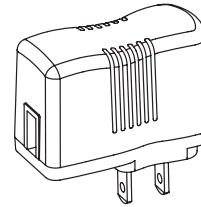

AC Adapter

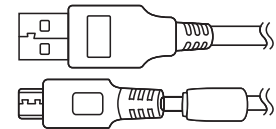

Micro USB Cable

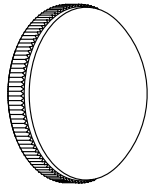

Lens Cover



Protective Cover

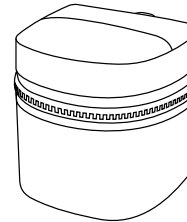

Carrying Case

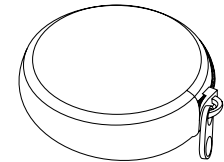

Small Lens Cover Case

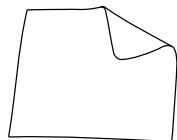

Cleaning Cloth



Quick Start Guide







Warranty Card

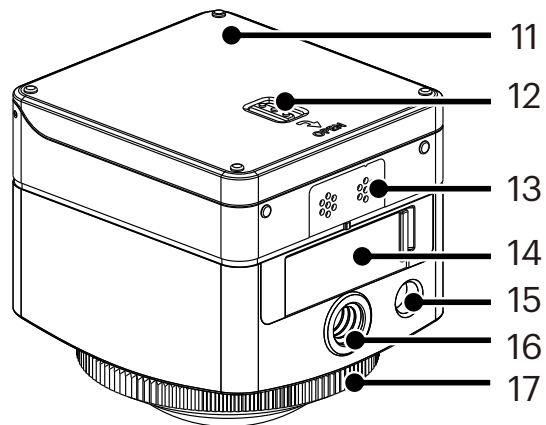
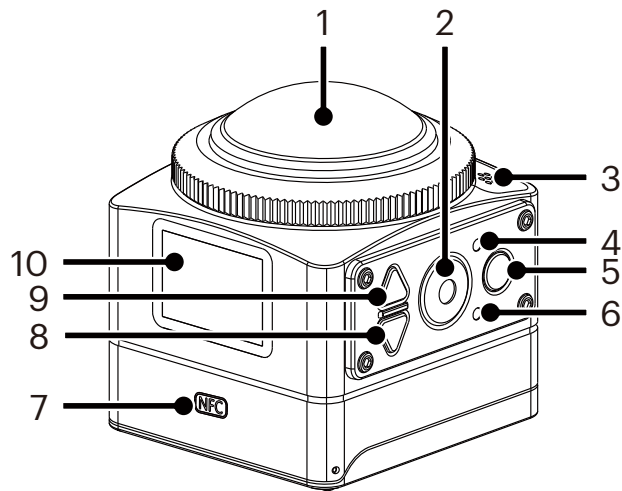

Service Card

## KODAK PIXPRO SP360 4K View



1	Lens
2	 Video Recording Button / Shooting Button / OK Button
3	Microphone
4	Status Indicator
5	 Wi-Fi Button
6	Wi-Fi Indicator
7	NFC Mark
8	 Menu Button / Direction Button (Lower)
9	 Power Button / Mode Button / Direction Button (Upper)
10	LCD
11	Battery Cover
12	Battery Cover Lock
13	Buzzer
14	Side Cover
15	Location Hole
16	Tripod Socket
17	Lens Ring

## Mounting / Removing Lens Ring and Lens Cover

The processes of mounting/removing lens ring and lens cover are the same, with lens cover as an example as below:

### Removing lens cover:

Turn the lens cover according to the illustrated direction until it separates from the SP360 4K.

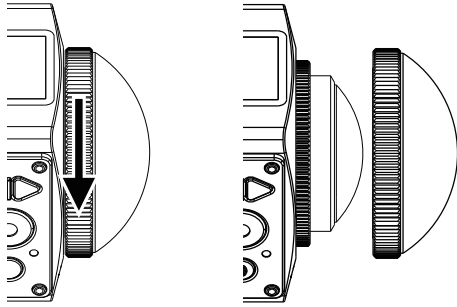

### Mounting lens cover

Turn and firmly tighten the lens cover according to the illustrated direction.

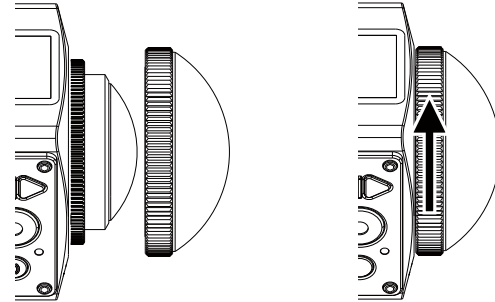

- ① Lens ring and lens cover cannot be used at the same time.
- ① The lens cover protects the lens from being damaged (dustproof, shockproof and splash proof). Using the lens cover when taking a photo/shooting a video will not influence the image/video quality.
- ① Before mounting the lens cover, make sure the lens surface is clean and dry. Always use a clean, lint-free dry cloth to clean the lens before shooting or recording so it will not affect the photo or video quality.
- ① When the SP360 4K is exposed to extreme temperature differences condensation may form inside of the lens cover. If this happens, remove the lens cover, clean it with a soft, dry, lint-free cloth, and then reinstall the lens cover.
- ① If the SP360 4K will not be used for a period of time, always put the protective cover on it (as shown in the figure).



## Installing Battery

### 1. Open the battery cover

Push the battery cover lock along the direction of arrow ①, push the battery cover along the direction of arrow ②, and open the battery cover along the direction of arrow ③.

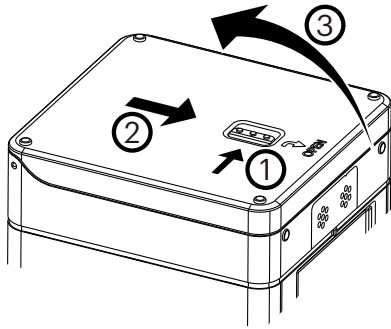

### 3. Close the battery cover

Cover the battery cover along the direction of arrow ⑤. Close the battery cover along the direction of arrow ⑥.

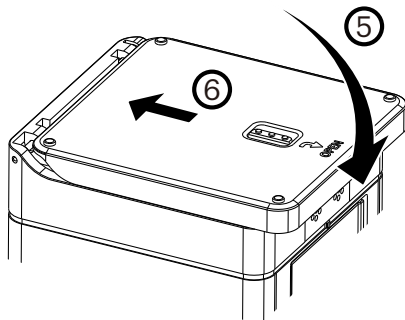

### 2. Insert the battery

Insert the battery into the battery compartment along the direction of arrow ④ (note the location of the + and - symbols).

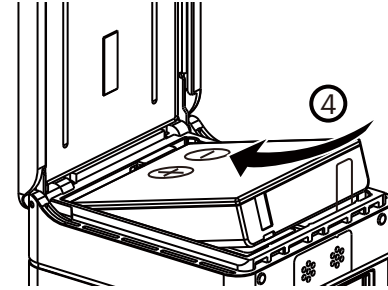

 Gently pull the tape upward to remove the battery. When inserting the battery, please do not fold the tape underneath the battery.

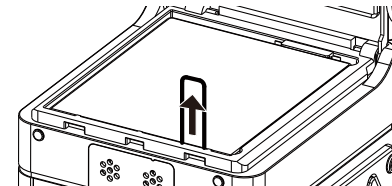

## **Installing Memory Card**

Open the side cover, then insert the memory card into the card slot (note the direction of the memory card gap), push the bottom end of the memory card with a fingertip into the slot completely, and then close the side cover.

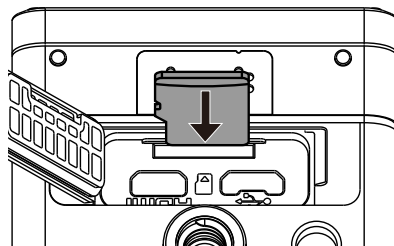

- ④ A memory card (microSD / microSDHC / microSDXC) is optional and is not included in the product package. It needs to be purchased separately. Please use an original memory card, which is Class 10 or higher and has a capacity of 8GB to 128GB. When recording with a memory card of Class 10 or above, in case of reminder of low speed, it is recommended to format the memory card before use.
- ④ To remove your memory card, open the side cover, gently press the memory card to eject it and remove it carefully.
- ④ The product will automatically turn off if the memory card is inserted or extracted when the product is on.

## **Charging the Battery**

 Please use the battery charger or AC adapter to charge the battery in an ambient temperature ranging from 10 °C to 35 °C.

### **Charging the battery with a battery charger:**

1. Place the battery into the battery charger according to the direction illustrated. Use the Micro USB cable to connect the battery charger and the AC adapter, and then plug the AC adapter into an electrical outlet.

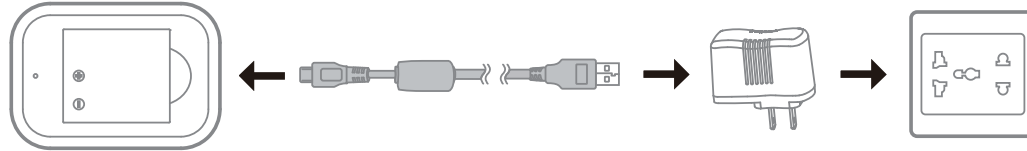

2. The indicator light will turn red while charging. The indicator light becomes green means charging is complete.

 When charging the battery for the first time or after a long period of storage, please make sure that the charging time is no less than four hours.

### **Charging the camera with an AC adapter or an external power supply (vehicle power supply, portable power supply, etc.):**

1. Place the battery into the camera.
2. While in shutdown mode, use the Micro USB cable to connect the camera to the AC adapter first, and then plug the AC adapter into the power outlet. Alternatively, use the Micro USB cable to connect the camera to an external power supply (vehicle power supply, portable power supply, etc.).

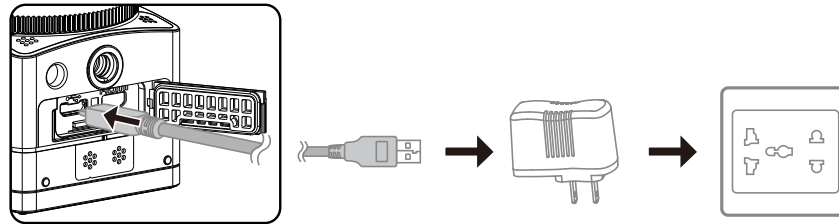

3. The indicator light will become orange while it is charging. The indicator will go out once charging is finished.

 The camera cannot be recharged when power is on.

### Charging the camera with a computer:

1. Place the battery into the camera.
2. Use the Micro USB cable to connect the camera (off) to a computer (on).
3. The indicator light will become orange while it is charging. The indicator will go out once charging is finished.

 The camera cannot be recharged when power is on.

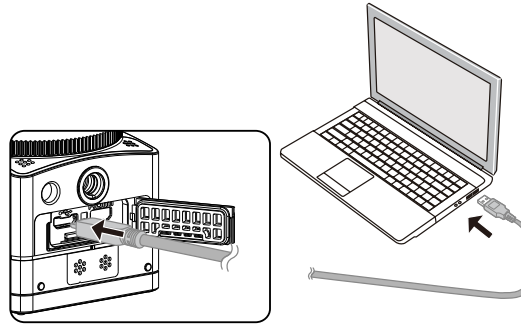



# Configuration and Operation

## Main Interface Introduction

### ■ The Main Interface

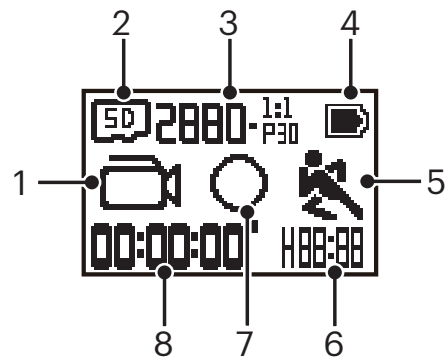

#### 1. Mode

- Movie mode
- Snap Shot Photo mode
- Loop recording mode
- Time-lapse movie mode
- High-speed movie mode
- Burst mode

#### 2. Memory card

3. Movie size: 2880-<sup>1:1</sup>/<sub>P30</sub> / 2048-<sup>1:1</sup>/<sub>P30</sub> / 1440-<sup>1:1</sup>/<sub>P60</sub> / 1440-<sup>1:1</sup>/<sub>P30</sub> / 1072-<sup>1:1</sup>/<sub>P60</sub> / 1072-<sup>1:1</sup>/<sub>P30</sub> / 720-<sup>1:1</sup>/<sub>P120</sub> / 4K-<sup>16:9</sup>/<sub>P30</sub>  
/ FHD-<sup>16:9</sup>/<sub>P60</sub> / FHD-<sup>16:9</sup>/<sub>P30</sub> / HD-<sup>16:9</sup>/<sub>P60</sub> / HD-<sup>16:9</sup>/<sub>P30</sub> / FWUGA-<sup>16:9</sup>/<sub>P60</sub> / HD-<sup>16:9</sup>/<sub>P120</sub> / FWUGA-<sup>16:9</sup>/<sub>P240</sub>

Photo size: 8-M/4-M/2-M

#### 4. Battery status

#### 5. Motion detection (on)

6. Remaining recording time: HH:MM hh:mm / MM:SS mm:ss / --:-- none

Number of remaining shots: +888888 :("+9999" will be displayed when it exceeds the maximum available display number) / ----- none

#### 7. Display mode

Global / Front

#### 8. Recorded time / photos ("+9999" will be displayed when it exceeds the maximum available display number)

## Power On / Off

### ■ Power on:





When the power is off, press and hold the  button for more than one second to turn on the product.

### ■ Power off:

When the power is on, press and hold the  button for more than one second to turn off the product.





 If the product cannot be powered off normally, you can remove the battery from the camera to force it to power off.







## Start-up for language, date and time

1. Press and hold the  button to turn on the product. When starting for the first time, the display will show the date and time setting screen, "Year Month Day Hour : Minute : Second".
2. The item to be adjusted will be highlighted with a black background color, press the  or  button to adjust the value, press the  button to confirm.
3. After adjusting the "Minute" value, press the  button to enter the main interface.



## Modes Introduction

In the main interface, press the  button to enter the mode selection interface. Press the  or  button to select any one mode; press the  button to the main interface of the current mode.

6 modes are available: Movie mode , Snap shot photo mode , Loop recording mode , Time-lapse movie mode , High-speed movie mode ,  
Burst mode .

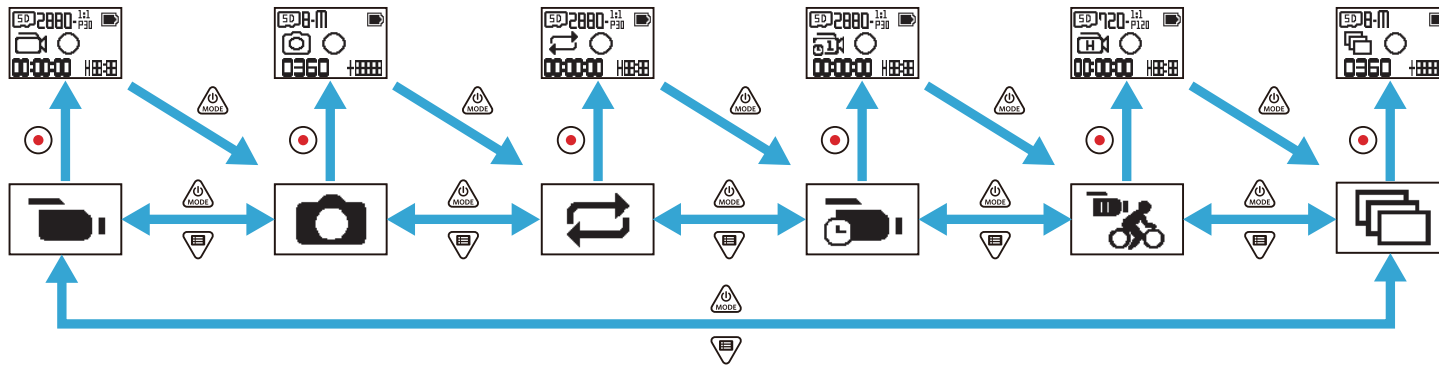

### ■ Movie mode

Enable video recording. It is suitable for recording in most conditions.

Operation method:

Press the  button to start recording. Press the  button again to stop recording.

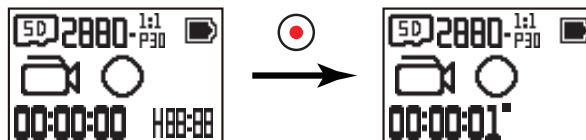

## ■ Snap Shot Photo mode

Enables photo shooting. It is suitable for recording in most conditions.

Operation method:

Press the  button for photo.

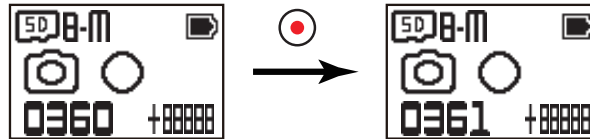



## ■ Loop recording mode

Loop recording refers to recording independent video segments in the unit of 2 minutes. The camera is only capable of saving a video of 60 minutes once maximally. If the recording at a time exceeds 60 minutes, the new video will automatically cover the earliest record in the folder in the unit of 2 minutes. The recording will be automatically stopped if the single recording time exceeds 24 hours.

Operation method:

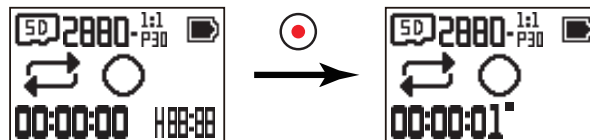
Press the  button to start recording. Press the  button again to stop recording.



 The video recording time varies in accordance with different capacities of memory card and movie size. Each time loop recording is executed, a new folder is generated.

## ■ Time-lapse movie mode

Time-lapse movie enables the recording of an interval of time, and splices the frames together to present a condensed video, which usually requires a long period to complete.

Operation method:

Press the  button to start recording. Press the  button again to stop recording.

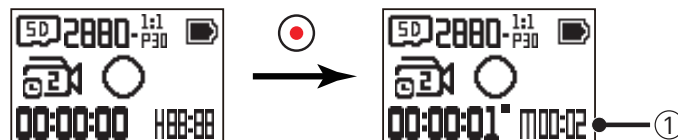

① indicates that the current countdown seconds

 Neither sound recording nor electronic image stabilization (EIS) function are supported.

## ■ High-speed movie mode

The product shoots ultra-high speed movies, and plays back with normal 30fps speed.

Operation method:

Press the  button to start recording. Press the  button again to stop recording.

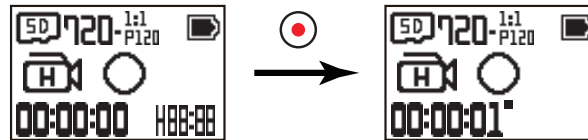

 Sound cannot be recorded in this mode.

## ■ Burst mode











Enables ten photos to be captured continuously before auto pause.

Operation method:







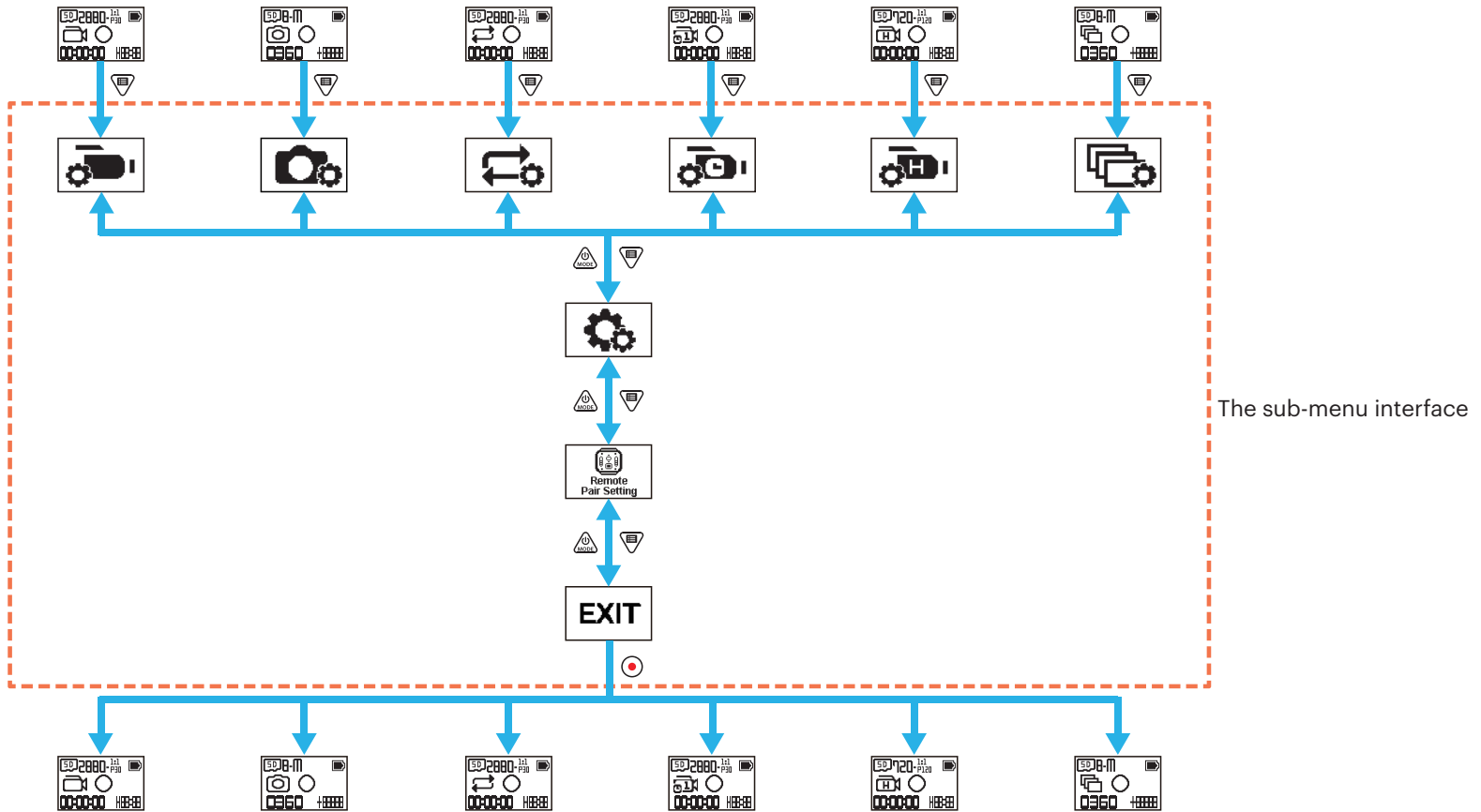

Press the  button; it will stop after 10 photos are taken.



## Introducing the Menu

- In the main interface, press the  button to enter the sub-menu interface. There are three items: Every Shooting Mode Settings ( /  /  /  /  / ), General Settings, Remote Pair Settings. Press the  or  button to select the item, and press the  button to enter the corresponding advanced setting interface.



- Press the  or  button to select the item; press the  button to confirm and to enter the selectable items interface (highlighted with a black background color).
- Press the  or  button to select the item; press the  button to confirm and to back to the advanced setting interface.
- Select , press the  button to return to the sub-menu interface.
- Select **EXIT**, press the  button to return to the main interface.

# Every Shooting Mode Settings / / / / /

The advanced Setting in every shooting mode

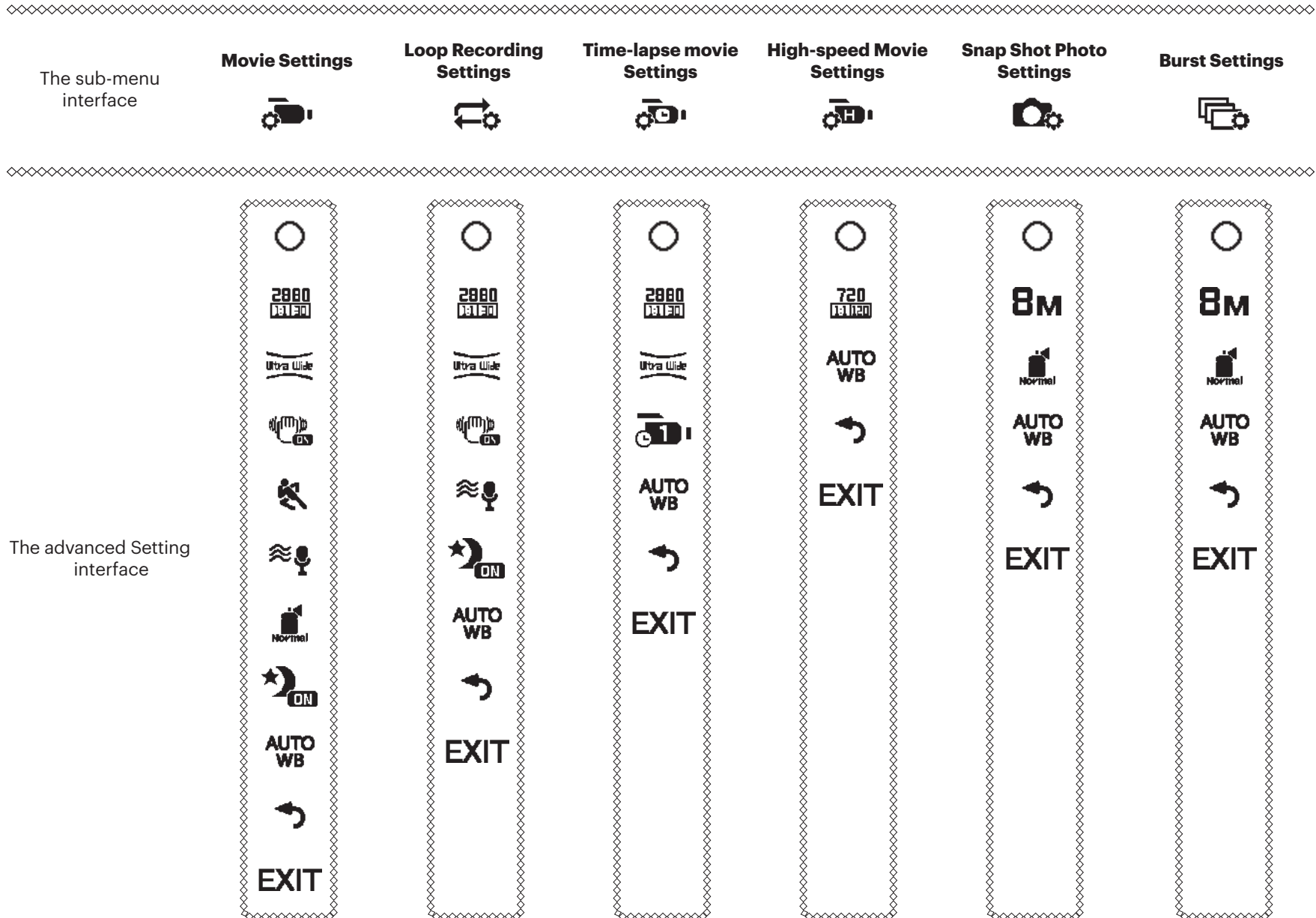

Take the recording setting menu as an example; the setting operating manners of other shooting modes are the same as that of the recording setting menu.

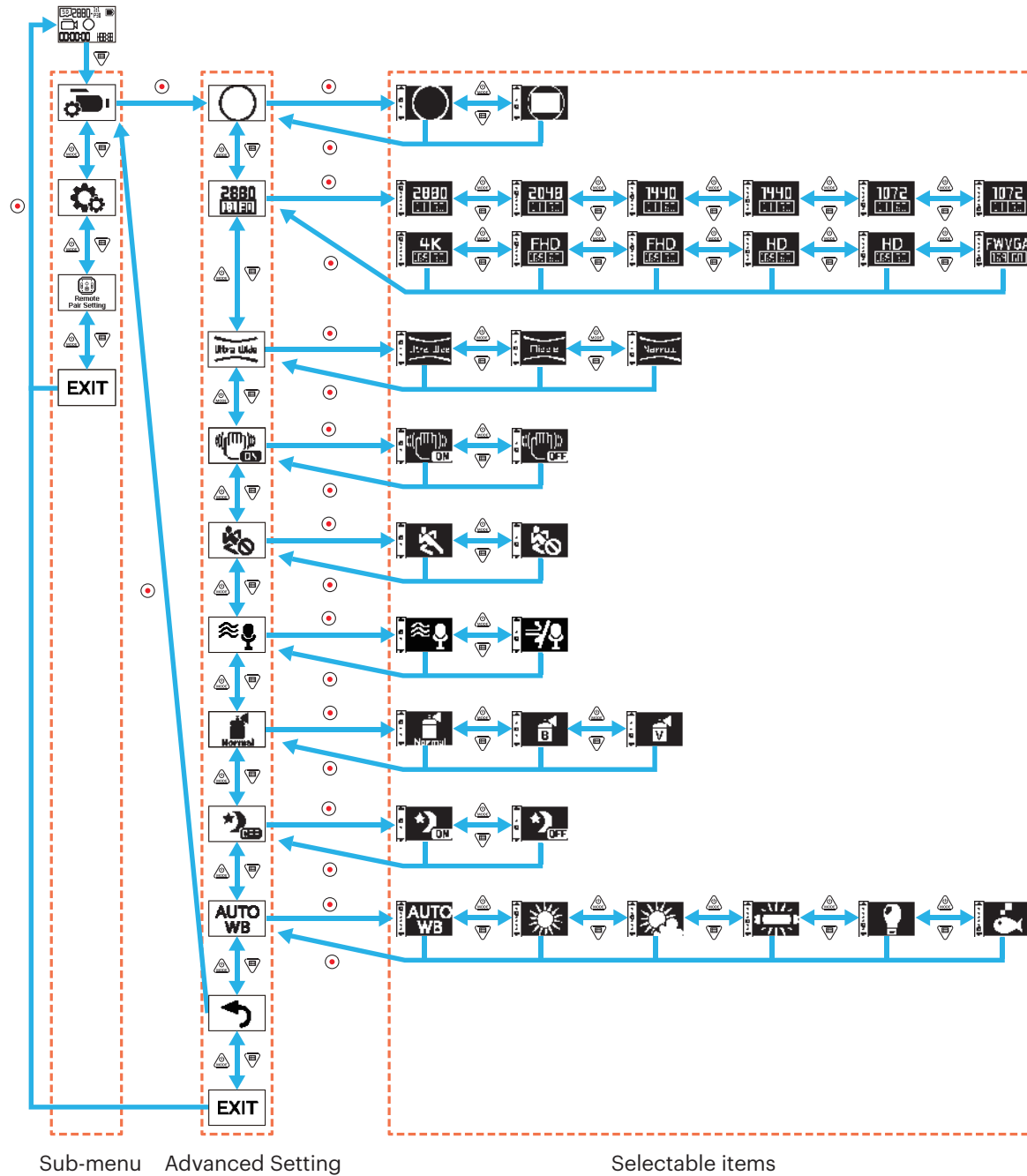



## ■ Display mode

Set image storage form.

There are 2 options:

- Global

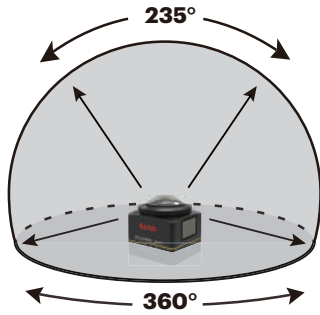



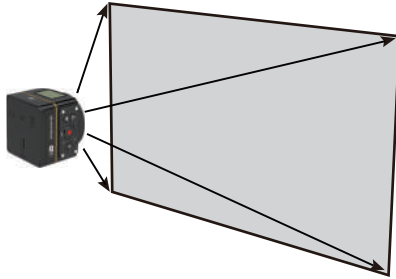











- Front







## ■ Movie size



Set video resolution.

There are 15 options :

-  2880×2880 (30fps)(1:1)
-  2048×2048 (30fps)(1:1)
-  1440×1440 (60fps)(1:1)
-  1440×1440 (30fps)(1:1)
-  1072×1072 (60fps)(1:1)
-  1072×1072 (30fps)(1:1)
-  3840×2160 (30fps)(16:9)
-  1920×1080 (60fps)(16:9)
-  1920×1080 (30fps)(16:9)
-  1280×720 (60fps)(16:9)
-  1280×720 (30fps)(16:9)
-  848×480 (60fps)(16:9)
-  720×720 (120fps)(1:1)
-  1280×720 (120fps)(16:9)
-  848×480 (240fps)(16:9)









 The selectable options are different for different modes, please be subject to actual operations.

 When the display mode is set to  , only the options having the dimension scale 1:1 are displayed; when the display mode is set to  , only the options having the dimension scale 16:9 are displayed.

 When select  to record, if the lens element faces towards a harsh light, a glow effect may occur.

 The maximum recording time:

Movie size	8GB	16GB	32GB	64GB	128GB
	0:14:30	0:29:20	0:58:50	1:58:00	3:56:30
	0:21:00	0:42:20	1:24:50	2:50:00	5:40:40
	0:41:20	1:23:00	2:46:40	5:33:30	11:08:10
	1:13:10	2:27:00	4:55:10	9:50:40	19:43:10
	0:52:40	1:45:50	3:32:30	7:05:40	14:11:50
	1:27:50	2:56:30	5:54:10	11:48:50	23:39:50
	0:43:50	1:28:10	2:57:00	5:54:20	11:49:50

Movie size	8GB	16GB	32GB	64GB	128GB
	0:14:30	0:29:20	0:58:50	1:58:00	3:56:30
	0:41:20	1:23:00	2:46:40	5:33:30	11:08:10
	1:13:10	2:27:00	4:55:10	9:50:40	19:43:10
	1:13:10	2:27:00	4:55:10	9:50:40	19:43:10
	2:08:40	4:18:20	8:38:20	17:17:20	34:37:50
	2:08:40	4:18:20	8:38:20	17:17:20	34:37:50
	0:32:00	1:04:30	2:09:30	4:19:20	8:38:20
	0:29:10	0:58:50	1:58:00	3:56:10	7:53:10







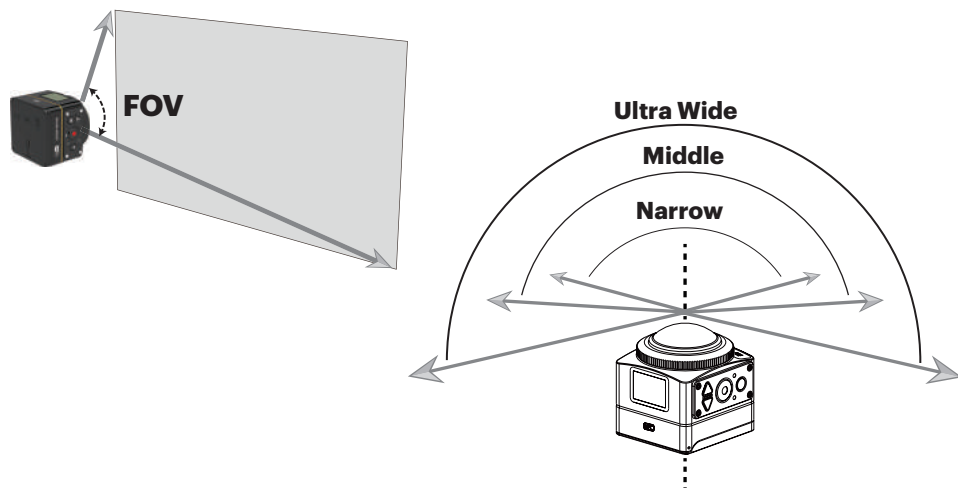

## Field of view

Field of view means the image receiving angle for the product.



There are 3 options:

-  Ultra Wide
-  Middle
-  Narrow



FOV		  	  
	4K	Ultra Wide	/
	FHD	Ultra Wide	
	HD FWVGA	Middle Narrow	
		/	

### Notes:

1. This function can be set only under front mode.
2. This function can be set only under the recording, loop recording and motion detection recording modes.
3. When  is set, the visual angle can only be set as .

## EIS

Set electronic image stabilization (EIS) function.

There are 2 options:

-  Enable
-  Off

FOV		
Ultra Wide	206°	235°
Middle	173°	188°
Narrow	150°	163°

## ■ Time-lapse movie

Set interval recording time.

There are 6 options:

-  1 second
-  2 seconds
-  5 seconds
-  10 seconds
-  30 seconds
-  60 seconds



## ■ Motion detection

Motion detection means that if the product detects moving objects entering into the view, it will automatically start recording. During the recording process, if there is no moving object detected for 10 continuous seconds, the recording will pause automatically.

There are 2 options:

-  Enable
-  Off

Operation method:

1. Select , and return to the main interface.
2. The display will show the  icon. Press the  button to activate. If the product detects moving objects, it will automatically start recording.
3. The product will stop recording when there is no change in the image within 10 seconds. When the image changes again, the product will start recording automatically, and a new video file will be generated after each pause and restart.

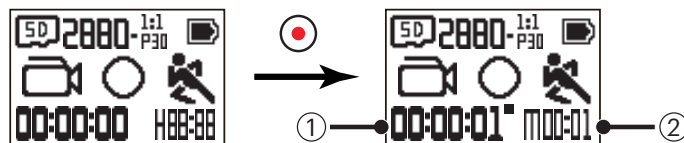

① indicates the total time of recording

② indicates the total time from enable the Motion detection

4. Press the  button again to stop recording and detecting.

## ■ Wind cut

Wind cut refers to the reduction of noise caused by wind.



There are 2 options:

-  Enable
-  Off

## ■ Color

Set image color.



There are 3 options:

-  Normal
-  Black and white
-  Vivid

## ■ Night view

When shooting at night or in the dark, enabling this function may enhance image brightness.

There are 2 options:

-  Enable
-  Off

 Note while using this function:

When in a bright environment, the image may be too bright.

Frame drop may occur.

It is recommended to use a tripod to avoid blurred images.

## ■ White balance

White balance means that the user adjusts the color temperature under different light sources to ensure that the colors are reproduced correctly.

There are 6 options:

-  Auto white balance
-  Daylight
-  Cloudy
-  Fluorescent
-  Incandescent
-  Underwater

 When enable the night view function, white balance will be set as  automatically.

## ■ Photo size

Set photo resolution.

There are 3 options:

- **8M** 2880×2880(1:1)
- **4M** 2304×1728(4:3)
- **2M** 1920×1080(16:9)

 Number of photos that can be stored:

Photo size	8GB	16GB	32GB	64GB	128GB
<b>8M</b>	1,590	3,190	6,400	12,810	25,660
<b>4M</b>	2,880	5,780	11,580	23,180	46,430
<b>2M</b>	6,720	13,490	27,030	54,090	108,350

# General Settings

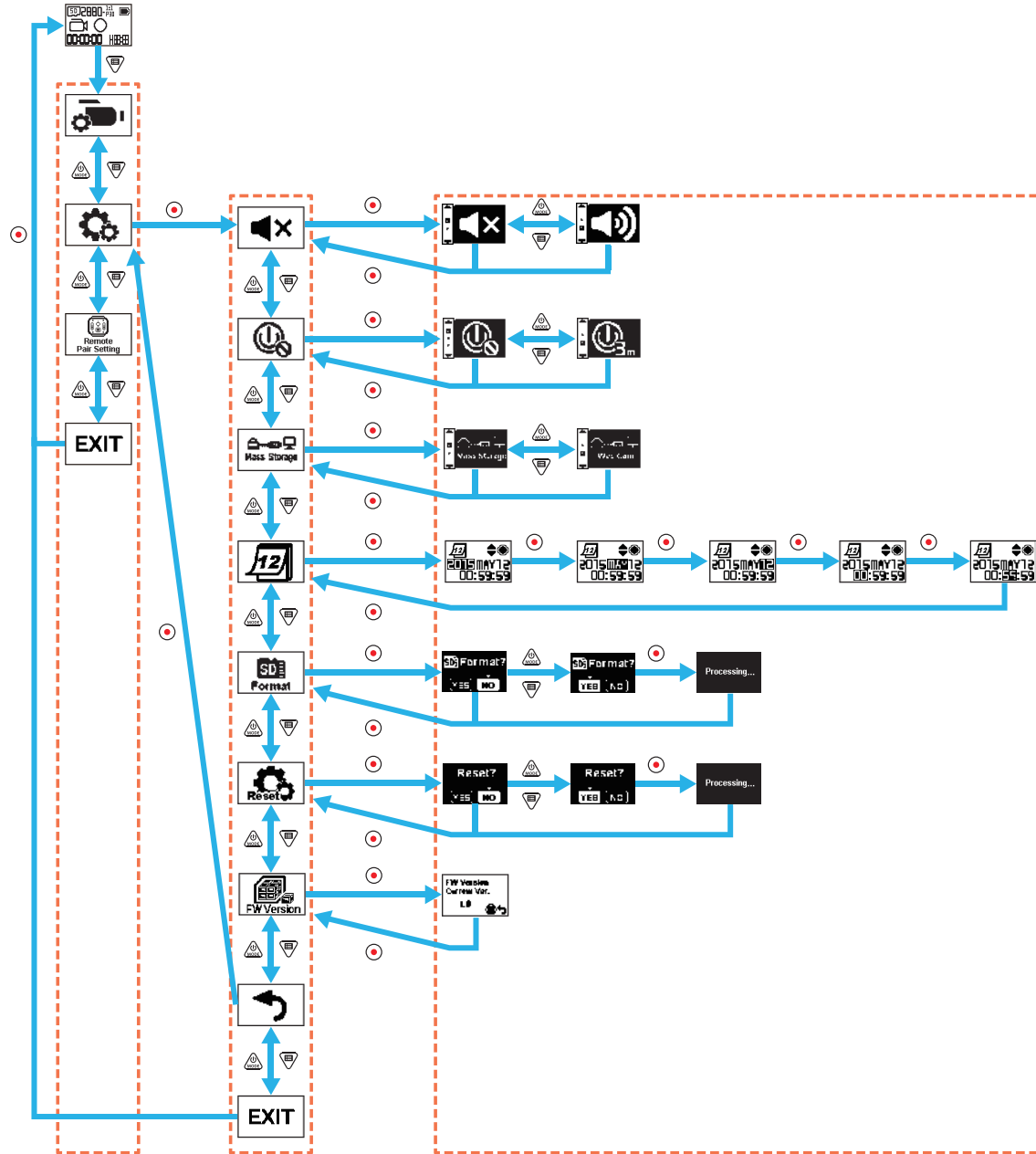

Sub-menu



Advanced setting

Selectable items

## ■ Volume

Set the volume of the product.

There are 2 options:

-  Enable
-  Off

## ■ Power off

When this function is enabled, if there are no actions taken within a set time frame (except while recording or connected to Wi-Fi), the product will automatically shut down.

There are 2 options:

-  3 minutes
-  Off

## ■ USB connection mode

The mode of connecting the Micro USB wire to the computer is set. If there is need to read or save videos, please select "Mass Storage". If there is need to serve as a video chat (Skype) camera, please select "Web Cam".





There are 2 options:

-  Mass storage
-  Web cam

 When the webcam is used, the power can only be supplied by the battery, so a fully charged battery is recommended.

## ■ Date / Time

Set the date and time of the product.

1. The display shows the date and time setting screen, "Year Month Day Hour : Minute : Second";
2. The item to be adjusted will be highlighted with a black background color, press the  or  button to adjust the value, press the  button to confirm;
3. After adjusting the "Minute" value, press the  button to enter the advanced setting interface.



## ■ **Format** Format

Format can clear all data stored in the memory card.

There are 2 options:

- **YES** Confirm
- **NO** Cancel

If select **YES**, press the  button to start formatting, and return to the advanced Setting interface after finishing.

## ■ **Reset settings** Reset

Reset settings can recover all product settings to the factory defaults (except for date and time).

There are 2 options:

- **YES** Confirm
- **NO** Cancel

If select **YES**, press the  button to start resetting, and return to the advanced Setting interface after finishing.

## ■ **FW version** FW Version

FW version can display the current version. Press the  button to return to the advanced Setting interface.

When a new version is stored in the memory card, the firmware can be updated.

There are 2 options:

- **YES** Confirm
- **NO** Cancel

If select **YES**, press the  button to start updating, and the product will automatically shut down after finishing.

 If the low battery warning is shown, charge the battery before updating the firmware.

### **NEW CAMERA OWNER / IMPORTANT INFORMATION**

Thank you for purchasing your new **KODAK PIXPRO SP360\_4K VR** camera. In an effort to provide you with the most up to date benefits and features of the SP360 4K, **we strongly encourage you to register your new camera on our website:**



**<https://kodakpixpro.com/support/product-registration>**

Doing so will keep you informed of important updates, including firmware, features and other important information that pertain to the SP360 4K. Your information is always kept secure, is encrypted and is never sold, shared or used for any purposes other than for SP360 4K camera specific notifications, unless you opt-in to receive other types of communications during the registration process.

## **Remote Pair Setting** Remote Pair Setting

Set remote pairing.

There are 3 options:

-  Remote off
-  Single Control
-  Multi Control



## Remote Control





A remote control can be used for remotely controlling the camera at a long distance.

The remote control is optional. If you need one, contact the local retailer to buy or access <http://kodakpixpro.com> for details of customer service.

You can wear the remote control on your wrist to perform long-distance control on the camera by operating the remote controller.

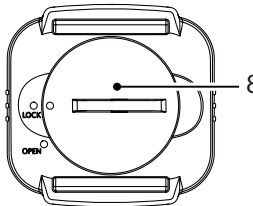
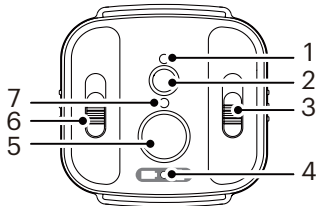
### Remote Control Appearance



1. Signal indicator lamp
2.  Signal test button
3. Shooting mode switch
4. Battery/Memory card indicator lamp
5.  Recording / Shooting button
6. Front/global mode switch
7. Shooting status indicator lamp
8. Battery cover

### Specifications

Model: RR-BK01

Dimension: 47×48×13.7mm

Weight: 27g (including battery)

Water proof: 5m (16 feet)

Crash proof: 2m (6.5 feet)

Dust proof: IP6X

Temperature: -10 to 40°C

Humidity: 0~90%

Battery: button cell CR2450

## Installing the Battery:

Open the battery cover plate with the included accessories tool in a counter clockwise direction. Insert the battery with the anode facing upward. Replace cover plate over battery and turn clockwise to lock into place.

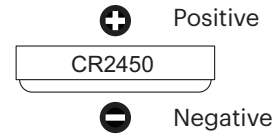
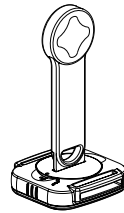



## How to Use:

1. Pair the camera and remote control

1.1. Method of one remote control for one camera:

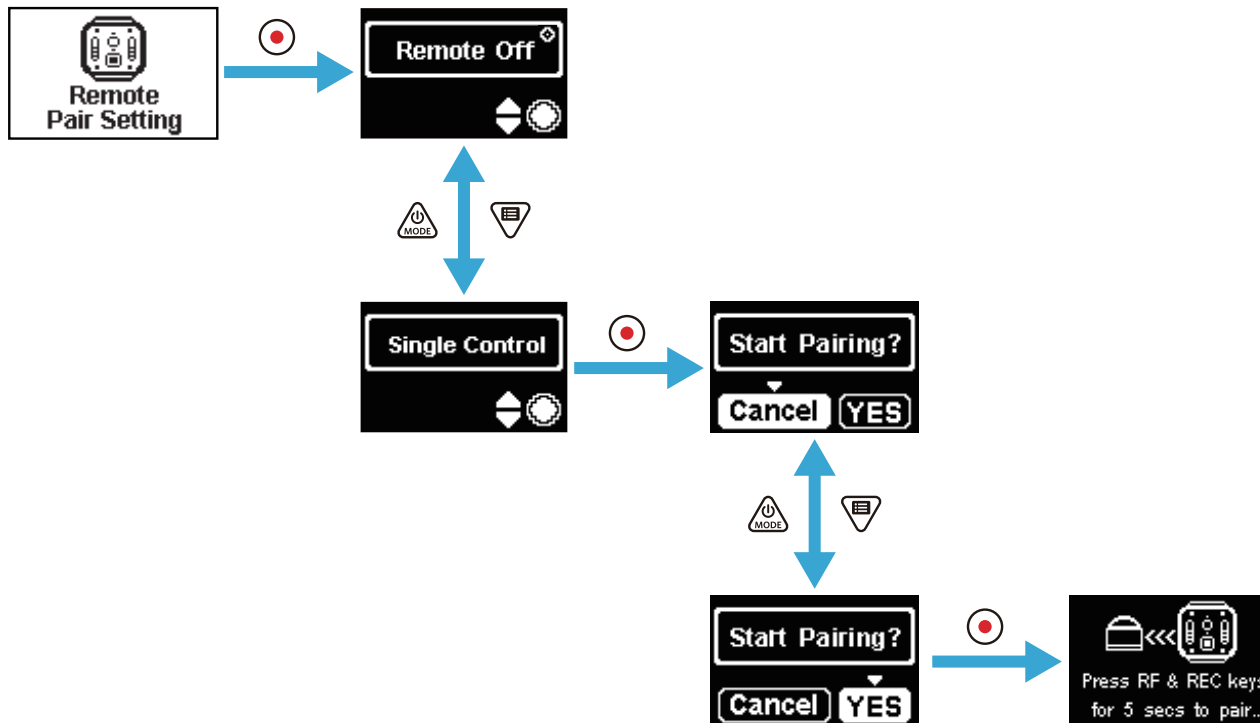
Press the  button in the main interface of the camera, select  Remote Pair Setting, press the  button. Select "Single Control", press the  button to enter the pairing confirmation interface, and then select **YES** and press the  button to confirm.







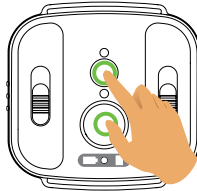

Press and hold the  and  buttons on the remote control simultaneously until pairing is successful.

 While pairing, the remote control shall be closer to the camera.



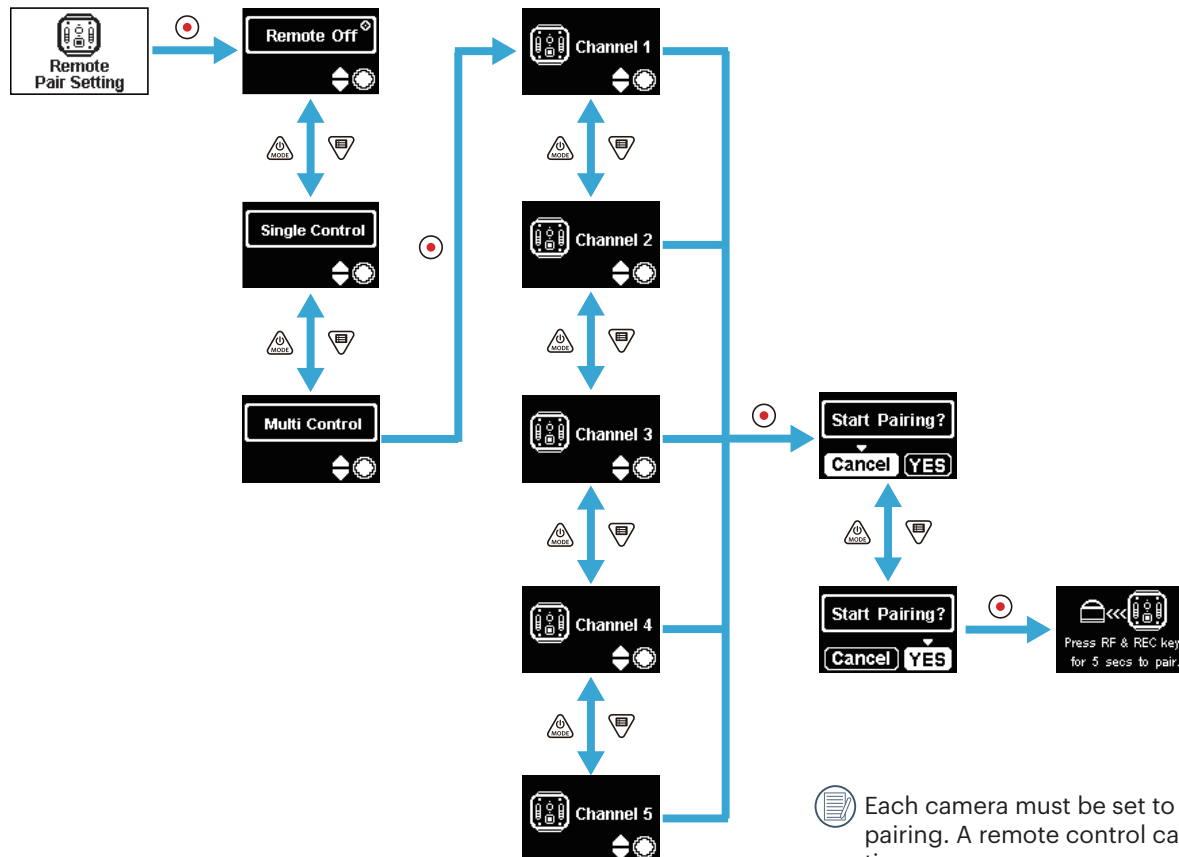

### 1.2. Method of one remote control for multiple cameras:

In the main interface of camera, press the  button, select  Remote Pair Setting, press the  button, select "Multi Control", press the  button to enter into channel setup interface, select any one channel, press the  button to enter into "Start Pairing?" interface, then, select **YES**, press the  button to confirm.





 Each camera must be set to the same channel (Channel 1-Channel 5) before pairing. A remote control can control a maximum of 5 cameras at the same time.



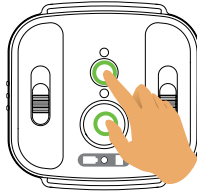

Repeat the above setup for each camera.

Press and hold the  and  buttons on the remote control at the same time until pairing is successful.

 While pairing, the remote control shall be closer to the camera.



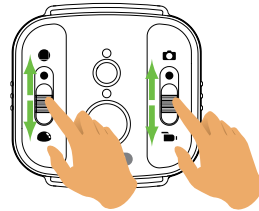

 For the successfully paired cameras, it is recommended to remove the battery (it will disconnect unless you reset the camera or shut it down in the "Remote Off" interface, otherwise it will not disconnect) to prevent the successfully paired camera from malfunctioning during the pairing process.

2. Set the desired shooting mode (movie mode  or snap shot photo mode ) and the display mode (Global  or Front .



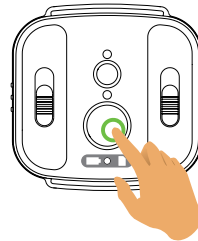

 Other parameters are set the same as the current settings of the camera at the same mode.

3.. Press the  button on the remote control to start shooting or recording, and press the  button again to stop recording.

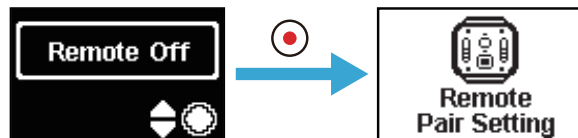

4. To terminate remote control, just press the  button on the "Remote Off" interface.



When  appears on the interface,



indicates that the camera is out of control of the remote control at the moment.



indicates that the remote control is under the control of one camera at the moment.







indicates that one remote control controls multiple cameras at this time.



It indicates that the camera has been set at this channel.

**In case of successful pairing between the camera and the remote control (the camera is capable of memorizing the remote control paired successfully last time):**

1. If the camera is powered off, the camera is powered on and start recording by pressing the  button on the remote control.
2. The camera is powered on or whether the remote control is paired successfully is tested by pressing the  button. The camera will be powered off by pressing and holding the  button (more than 1.5 seconds).
3. When the  button on the remote control is pressed to start recording or shooting, the camera works with the current setting of the remote control.

 If the camera has been powered off for more than 6 hours, it is impossible to power on the camera directly with remote control.

**Indicator lamp status description:**

1. If pairing succeeds, the signal indicator lamp turns green.
2. If pairing fails, the signal indicator lamp turns red.
3. During remotely controlled recording or shooting, the shooting status indicator lamp turns orange. When using "Multi Control", the shooting status indicator lamp will not illuminate.
4. When the battery level of the camera is less than 25% or the memory card is full, the battery/memory card indicator lamp turns red.

**Precautions: :**

1. If the Wi-Fi (NFC), HDMI connection or computer connection of the camera are already enabled, the remote control function is unavailable.
2. When only one camera needs to be controlled, the "Multi Control" is not recommended. When using "Multi Control", the effective working distance of the remote control may be shortened.
3. The remote control operates at band 2.4GHz. Since microwave ovens, radios and amateur radios also use the same cyclic wave, it is possible to generate radio interference.
4. Before using the remote control, make sure there are no other electronic devices or radio stations, etc. around. Please use it in an environment with better permeability and free from obstructions.
5. Radio interference and other reasons may cause malfunction of the remote control. Pay attention to the actual condition of the camera when using the remote control.

# Using Interfacing

## Micro USB interface

### Charging



### Using an external power supply

In case of low battery power, or when a long-term power supply is needed, an external power supply (AC adapter, vehicle power supply, portable power supply or other power unit) can be used instead of a battery. At this time, the setting of functions, photography, and other operations can be performed.

When powered on, use the Micro USB cable to connect the camera to an external power supply. When connected with an external power supply, "⏻" will be displayed on the LCD.

When powered off, use the Micro USB cable to connect the camera to the external power supply. Press and hold the  button to power on. When connected to an external power supply, "⏻" will be displayed on the LCD.

 Requirements for the external power supply: output power of 5 V, output current of 1 A.

 Insert the battery into the camera before using an external power supply to charge.

### Data transmission

Use the Micro USB cable to connect the camera to a computer and copy files from the camera to the computer.

The steps are as follows:

1. Set the USB connection mode as  in the camera menu.

2. Use the Micro USB cable to connect a computer (on) to the camera (on). During the connection, the camera will display "⏻" and the computer will automatically detect the camera.

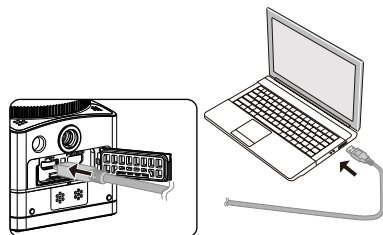

3. Open the camera folder on the computer to copy your files to the computer. After the transmission is completed, please unplug the USB cable in a safe manner according to the computer's settings.

4. The camera will automatically shut down when the Micro USB cable is unplugged.

 Your computer operating system version needs to be Mac OS X10.9 and above or Window 7 and above.



SP360 4K



DCIM



The folder structure of a microSD card on which this unit has performed recording is as follows.

Example folder structure of a microSD card:

- Folder numbers range from 100 to 999. Four or eight alphabetic characters after a three-digit number indicate the file type.

**A. Still pictures in JPEG format** (Each folder stores a maximum of 999 still pictures)

**B~M. Movie files in MP4 format** (Each folder stores a maximum of 99 files) ([101\_0001.MP4] etc.)

- B. 2880×2880/30p
- C. 2048×2048/30p
- D. 1440×1440/60p
- E. 1440×1440/30p
- F. 1072×1072/60p
- G. 1072×1072/30p
- H. 3840×2160/30p
- I. 1920×1080/60p
- J. 1920×1080/30p
- K. 1280×720/60p
- L. 1280×720/30p
- M. 848×480/60p

**N~P. High-speed movie files** (MP4 format) ([113\_0001.MP4] etc.)

- N. 1/4 times normal speed (720×720/120p)
- O. 1/4 times normal speed (1280×720/120p)
- P. 1/8 times normal speed (848×480/240p)

**Q~R. Administrative files**

- The size of a video file will not exceed 4G or the time length will not exceed 30 minutes. When a new file is generated automatically during recording, the recording process will not be interrupted. Recording in time-lapse mode may last for up to 72 hours.
- The video files recorded by SP360 4K cannot be played in the application program (Windows Media Player) supplied with Windows7. Play using the application program dedicated for SP360 4K.



## Webcam

Connect the camera and computer via a Micro USB cable and use the camera as a Webcam.

1. Download the drivers for the app "PIXPRO SP360 4K UVC" from the official website and install it onto the computer as prompted on the screen.

Americas / Europe



<http://kodakpixpro.com/Americas/support/downloads.php>

2. Set the USB connection method as  from the camera menu.

3. Connect the computer (turned on) and camera (turned on) via a Micro USB cable. While connecting, the camera displays " " and the computer detects the camera automatically.

4. Open the video software (Skype) in the computer, and select "Options..." from "Tools". Click on "Video settings" and select "PIXPRO SP360 4K UVC" as the video input device. By clicking on "Webcam settings", you may change various settings.

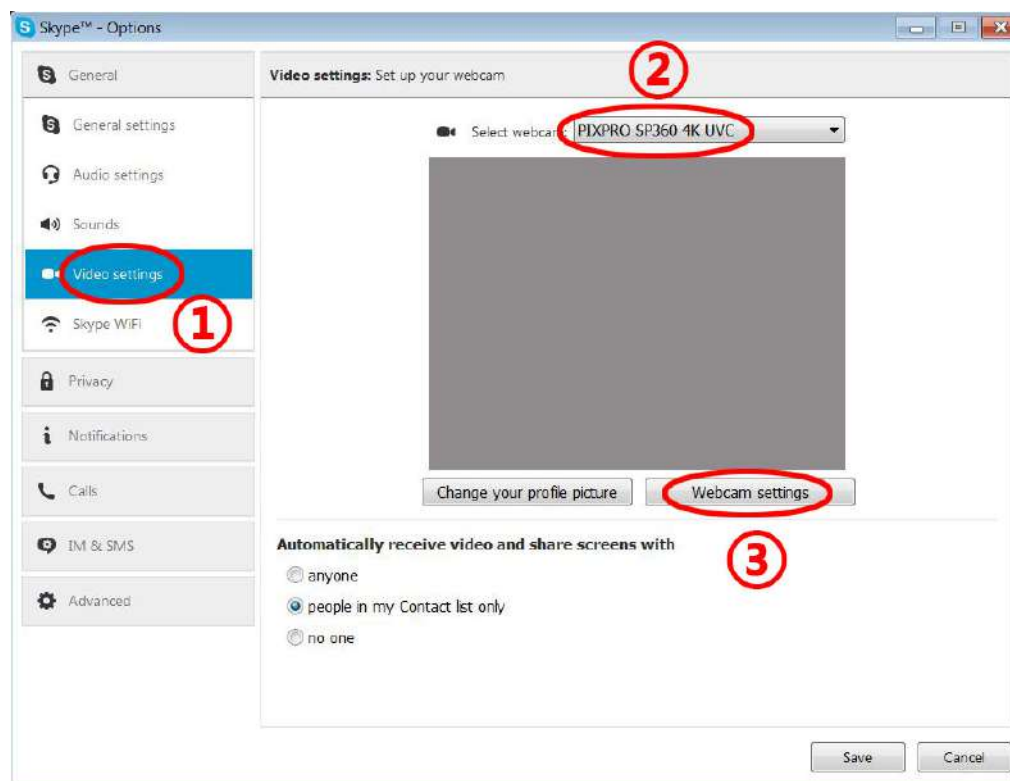

5. Change the desired settings and click on “OK” to exit.

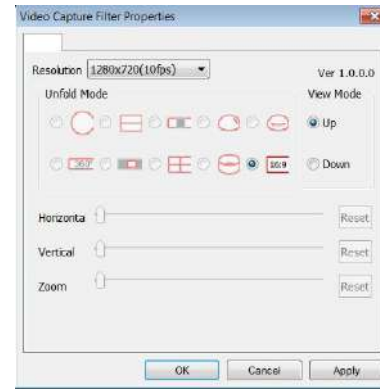

- ☰ If you choose a resolution of 1280×720, the image will be displayed at an aspect ratio of 16:9.
- ☰ In the image position adjustment menu list, O stands for available, and X for unavailable.

Horizontal	O	O	O	O	O	O	O	O	O	X
Vertical	X	O	O	O	O	O	O	O	O	X
Zoom	X	O	O	O	O	O	O	O	O	X

- ☰ This function supports Windows 7 and higher OS. (Graphics GPU must support Direct3D 10.)
- ☰ Applicable video software: Skype™.
- ☰ The Webcam consumes battery power, so we recommend you use fully recharged batteries. (In case of fully recharged batteries and HD image quality, it may work about 6 hours.)
- ☰ The Webcam function is not available if no batteries are inserted into the camera.
- ☰ While using the Web Cam mode, the camera can only be connected to the USB interface with CDP feature, and it may consume the battery power. (Please connect to the USB interface with the camera turned on.)





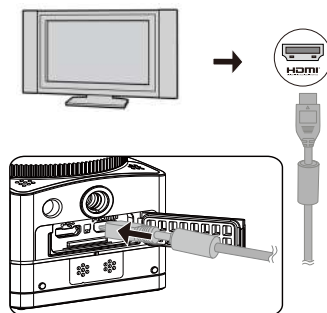

## Micro HDMI interface

The television (on) up to the HDMI standard and the camera (on) are connected by use of a Micro HDMI wire (bought independently).















After the connection succeeds, the documents in the memory cards of the camera are displayed on the television, while  is displayed on the camera.

### The shooting and playback functions can be realized by use of the camera:







1. Press the  button to switch between the video playback mode, the photo playback mode and the shooting mode.
2. Press the  or  button to browse the documents in the playback modes.
3. Press the  button to start playing and press the  button again to stop playing while playing back the recording documents.
4. Set parameters according to requirements in the menu firstly in the shooting mode, and then return to the main screen, press the  button to shoot or start recording, and press the  button again to stop recording.

 In the liveview screen, the frame rate depends on the size of the video or photo.

 In the following setting states, During the recording process, it is not possible for the camera to realize real-time HDMI output:

Shooting mode	Display mode	Movie size
		2880 2048  
		4K 
		720 
		HD FWVGA  

### The playback function can be realized by use of the television remote control:

1. Press the left and right keys to switch the documents.
2. Press  to switch the video document  and the photo  .
3. Press  to hide or display the screen information.
4. For browsing the video document, press the central key to start playing, press the left key to fast reverse, press the right key to fast forward, and press the central key again to pause playing.
5. Press  to delete the current document and select  to confirm deletion.
6. Press  to stop playing.

 Only the HDMI television having the CEC (Consumer Electronics Control) function supports the function.

## Download and Install App

- Smart Device:

Download the App installation package (App name: PIXPRO SP360 4K)  to your smart device from the path below, and install it by following the instructions on the interface.

For Android devices, search and download the App "PIXPRO SP360 4K" in Google play, and install it by following the instructions on the interface.



For iOS devices, search and download the App "PIXPRO SP360 4K" in App Store, and install it by following the instructions on the interface.



- PC:

Download Application "PIXPRO 360 VR SUITE" (for PC) installation package  from the official website, and install it on your computer by following the prompts on the interface.

Americas / Europe



<http://kodakpixpro.com/Americas/support/downloads.php>



Please review the following items before your first connection:

1. Please do not use in places having high intensity magnetic field, electrostatic and electric wave interference (for example near a microwave oven), which may cause failure in receiving signals.
2. Please do not use Wi-Fi or NFC connection functionality on a plane.
3. To maintain in connection, please keep SP360 4K within 10 meters (32.8 feet) without signal shielding interference.
4. SP360 4K and the smart device can only be connected one to one.
5. SP360 4K and PC only can be connected one to one.
6. Your smart device operating system version needs to be iOS 14 or higher, or Android 8.0 or higher. iPad mini1 / iPad 2 / iPhone 4s and earlier models (any system versions) do not support this App.
7. Your computer operating system version needs to be Mac OS X10.9 and above or Window 7 and above.

## Connect camera to smart device (or PC) with Wi-Fi.

Operation method:

### 1. Camera:

Check SSID (Service Set Identifier) (PIXPRO-SP360-4K\_XXXX) indicated on the label in the battery compartment of the camera and input the randomized and unique Wi-Fi® password displayed on the “Waiting Connect” screen (See the image below on the right). Press the  button to enable Wi-Fi mode. The camera will enter the waiting for connection interface one second later:



### 3. Camera:

When the Wi-Fi connection is successful, enter the Wi-Fi connection interface.



### 5. Camera:

When the App is connected to the camera, the App connected interface will appear.



When recording is started via the App, the recording interface will appear on the camera.





### 2. Smart Device or PC:

Enable Wi-Fi mode, it will automatically search the nearby Wi-Fi hotspots. Select the one with the same SSID (PIXPRO-SP360-4K\_XXXX) and input the password.



### 4. Smart Device or PC:

When connected via Wi-Fi, you can tap the App icon  on the smart device to start it; or double-click the App icon  on the desktop of the computer to start it.

 Every SP360 4K camera is shipped with a default factory Wi-Fi® password that is randomized and unique to that camera and will not change unless you wish to reset the password with a new randomly generated password. If you wish to change the Wi-Fi® password in your SP360 4K from the assigned, unique factory password, you can do so by selecting and using the Reset setting. If “Reset” is selected, a new random password will be generated and saved in the camera until changed or if you use the “Reset” function again. (Please refer to Reset instructions on page 31).

④ If the Wi-Fi connection is cut off while recording, the camera will continue to record and enter the connectionless recording interface.



④ When  displays in the interface, press the  button, and press the  or  button to select **YES**, and then press the  button to exit the Wi-Fi connection.

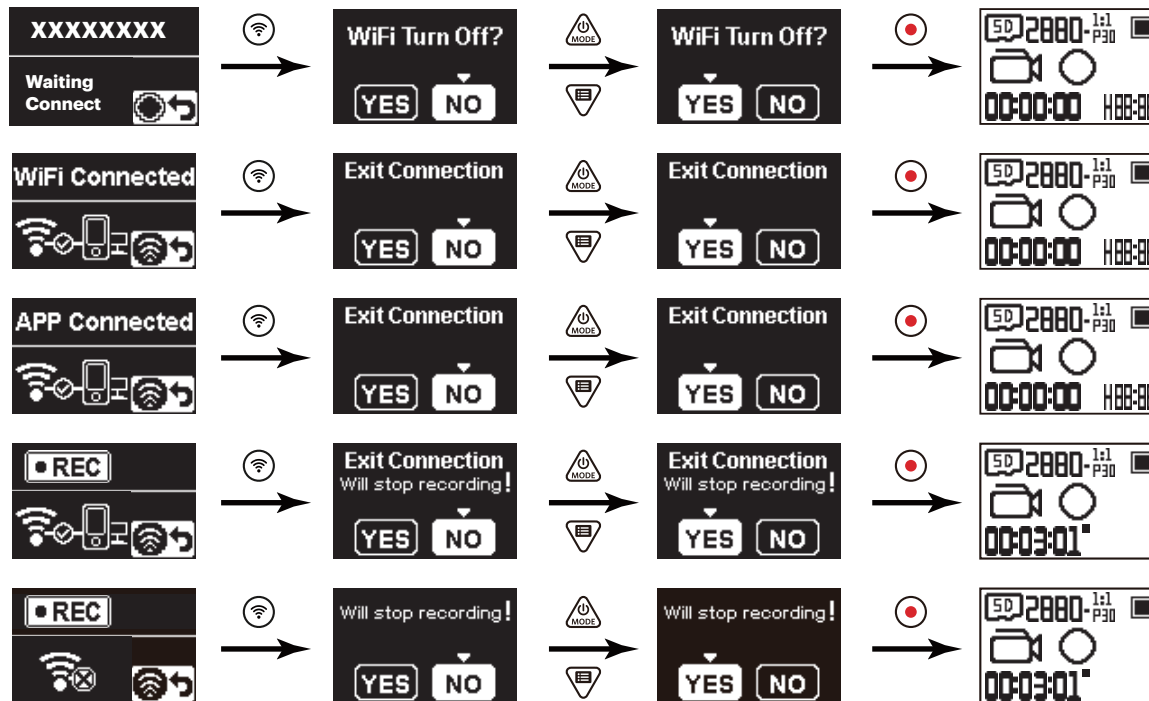

### Connect camera to smart device with NFC

1. Enable NFC mode on your smart device.
2. Use your smart device to lightly touch the NFC mark on the camera. If the smart device has a prompt tone or vibration, it means the connection is successful.

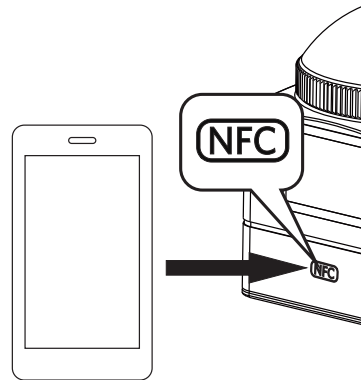

3. The App will open automatically on your smart device.

 The NFC feature will only be available when your smart device's screen is unlocked.



# Appendices

## Specifications









 Design and specifications are subject to change without notice.





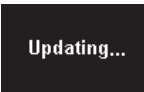

Image Sensor	Type	1/2.3" BIS CMOS
	Effective Pixels	12.40 Megapixels
	Total Pixels	12.76 Megapixels
Lens	Focal Length	0.85mm
	Equivalent to 35mm film	8.2mm
	F Number	F2.8
	Lens Construction	7 groups 9 elements
	Optical Zoom	Fix Focus
	Field of View	Max. 235 Degree (without lens cover)
	Focusing Range	50cm~∞
Anti-Handshake	Electronic Image Stabilization	
Number of Recording Pixels	Photo Size	8M : 2880×2880(1:1) 4M : 2304×1728(4:3) 2M : 1920×1080(16:9)
	Movie Size	2880×2880 30fps (1:1) 2048×2048 30fps (1:1) 1440×1440 60fps/30fps (1:1) 1072×1072 60fps/30fps (1:1) 3840×2160 30fps (16:9) 1920×1080 60fps/30fps (16:9) 1280×720 60fps/30fps (16:9) 848×480 60fps (16:9)  High-speed Movie : 720×720 120fps (1:1) 1280×720 120fps (16:9) 848×480 240fps (16:9)

File Format	Photo	Exif 2.3 (JPEG)
	Movie	MP4 [Image: H.264; Audio: AAC(Stereo)]
Modes	Movie, Snap Shot Photo, Loop Recording, Time-lapse movie, Burst, High-speed Movie	
Splash proof	Equivalent to JIS/IEC IPX5 (Body)	
Shockproof	Up to 2m (with lens cover)	
Dustproof	Equivalent to JIS/IEC (IP6X)	
Freeze-proofing	-10°C	
LCD	1.0 inch TN LCD	
Level Gauge	3-axis	
ISO Sensitivity	Auto (100~800)	
Exposure Metering Method	Artificial Intelligence AE (AiAE)	
Exposure Control Method	Program AE	
Burst	Supported	
White balance	Auto white balance, Daylight, Cloudy, Fluorescent, Incandescent, Underwater	
Recording Media	Internal Memory: No	
	microSD / microSDHC / microSDXC Card (Up to 128GB Support) [MMC Card Not Supported]	
Language	English	
Interface	USB 2.0 (Micro 5 pin USB) , HDMI (Type D)	
Wi-Fi	Supported (802.11b/g/n)	
NFC	Supported	
Remote Control	Supported	

Power	Rechargeable Li-ion Battery LB-080, 3.6V 1250mAh, In-Camera Charging
Shooting Capability (Battery Performance)	Approx. 160 shots (Based on CIPA Standards) (Wi-Fi on) Approx. 55 minutes for Video (@3840×2160/30fps) (Wi-Fi on)
Operation Environment	Temperature: -10 ~ 40°C, Humidity: 0 ~ 90%
Dimensions (W×H×D)	Approx.48.0×50.0×52.5 mm (Without lens cover) (Based on CIPA Standards)
Weight	Approx. 102g (Only body) Approx. 128g (With battery and memory Card)

## Prompts and Warning Messages

Message	Description	Processing mode
	<ul style="list-style-type: none"> <li>■ There are too many files, which may cause a delay to power on.</li> <li>■ When pressing the  button for shooting, the memory card cannot be accessed because there are too many folders.</li> </ul>	<ul style="list-style-type: none"> <li>■ After copying the files to the computer, choose to delete or format.</li> </ul>
<b>No Card</b>	<ul style="list-style-type: none"> <li>■ No memory card is detected in the camera.</li> </ul>	<ul style="list-style-type: none"> <li>■ Insert the memory card.</li> </ul>
	<ul style="list-style-type: none"> <li>■ When turning on the product or pressing the  button, the product detects that the memory card is out of capacity.</li> </ul>	<ul style="list-style-type: none"> <li>■ After copying the files to the computer, choose to delete or format.</li> </ul>
	<ul style="list-style-type: none"> <li>■ The memory card still cannot be recognized after format.</li> <li>■ An error occurs when reading the memory card.</li> <li>■ Interruption is encountered during shooting or recording so it cannot be shooting or recording any further.</li> </ul>	<ul style="list-style-type: none"> <li>■ Format the memory card.</li> </ul>
	<ul style="list-style-type: none"> <li>■ When the writing speed is too slow, recording will not continue.</li> </ul>	<ul style="list-style-type: none"> <li>■ Please select a Class 10 memory card or above. A memory card of Class 10 or above may remind you of being too slow due to the card condition.</li> </ul>
	<ul style="list-style-type: none"> <li>■ File processing (saving, formatting, etc.) time exceeds 2 seconds.</li> </ul>	<ul style="list-style-type: none"> <li>■ User should do nothing.</li> </ul>
	<ul style="list-style-type: none"> <li>■ Connecting to the computer or TV.</li> </ul>	<ul style="list-style-type: none"> <li>■ The display will disappear after connection is successful.</li> </ul>

Message	Description	Processing mode
	<ul style="list-style-type: none"> <li>■ The camera is set as "Mass Storage", connecting to the computer USB.</li> </ul>	<ul style="list-style-type: none"> <li>■ User should do nothing.</li> </ul>
	<ul style="list-style-type: none"> <li>■ The camera is set as "Web Cam", connecting to the computer USB.</li> </ul>	<ul style="list-style-type: none"> <li>■ User should do nothing.</li> </ul>
	<ul style="list-style-type: none"> <li>■ Connecting to the HDMI device.</li> </ul>	<ul style="list-style-type: none"> <li>■ User should do nothing.</li> </ul>
	<ul style="list-style-type: none"> <li>■ A warning for low battery before shutting down automatically.</li> <li>■ The firmware cannot be updated when power is insufficient.</li> </ul>	<ul style="list-style-type: none"> <li>■ Charge or replace with a new battery.</li> </ul>
	<ul style="list-style-type: none"> <li>■ Updating firmware.</li> </ul>	<ul style="list-style-type: none"> <li>■ User should do nothing. The product will turn off automatically after the update is completed.</li> </ul>
	<ul style="list-style-type: none"> <li>■ The product will automatically shut down when the battery temperature becomes too high.</li> </ul>	<ul style="list-style-type: none"> <li>■ Remove the battery carefully when the product is shut down. The battery will be good to use again after cooling down.</li> </ul>





## **Trouble Shooting**

<b>Problem</b>	<b>Possible causes</b>	<b>Solution</b>
Product does not turn on	<ul style="list-style-type: none"><li>■ The battery has been depleted.</li><li>■ The battery is installed incorrectly.</li></ul>	<ul style="list-style-type: none"><li>■ Charge the battery.</li><li>■ Please follow the charging instructions in the manual to install the battery.</li></ul>
Blurred images	<ul style="list-style-type: none"><li>■ There is dirt on the lens or the lens cover.</li></ul>	<ul style="list-style-type: none"><li>■ Clean with a clean, lint-free dry cloth.</li></ul>
Failed to connect Wi-Fi	<ul style="list-style-type: none"><li>■ Wrong password entered.</li></ul>	<ul style="list-style-type: none"><li>■ Re-enter the password. If you have forgotten the password after changing it from the default factory password, you can use the “Reset” function to get another new randomized and unique Wi-Fi® password.</li></ul>
Slow Wi-Fi connection	<ul style="list-style-type: none"><li>■ There are too many programs running simultaneously on the smart device.</li></ul>	<ul style="list-style-type: none"><li>■ Please close other unnecessary programs running on the smart device.</li></ul>
Micro USB connection failure.	<ul style="list-style-type: none"><li>■ Choose the wrong USB connection mode</li></ul>	<ul style="list-style-type: none"><li>■ Confirm the USB connection mode set in the menu. If there is need to read or save videos, please select Mass Storage. If there is need to serve as a video chat (Skype) camera, please select Web Cam.</li></ul>

## ***Special Accessories***

---

There are different options of SP360 4K accessories available. Accessory bundles vary per retailer. To purchase additional accessories separately, please contact your local retailer customer service support, or visit [kodakpixpro.com](http://kodakpixpro.com) for more customer service details.

-  Taking the status of using the lens ring as an example in the introduction of the section, you can select to use the lens cover according to the actual use conditions (for instance, if stronger waterproof and dustproof properties are required).
-  Before using (especially in water or strenuous activity), please pay attention to make sure the product is tightly secured to prevent damage or loss of the product.
-  Please ensure that the adhesive surface is clean before using double-sided adhesive accessories. Dirt, grease, or other foreign matter will reduce the effectiveness of the double-sided adhesive. The double-sided adhesive is not easy to remove after sticking. Please take into account the position and angle of sticking before doing it.
-  After fully assembling the accessories, please make sure the screw is in the proper position and fully secure.

**Standard Housing: For use with other accessories when waterproofing is not required**



Installation method:

1. The standard housing is pulled open from the bottom and then sleeves the camera.
2. Install the holder on the accessories, and use the setscrew to tighten.



3. Use the accessories tool to tighten the setscrew.



Accessories Tool



**Waterproof Housing: For use with other accessories underwater, in rain, on the seashore, or in other circumstances where waterproofing is required**



Installation method:

1. Remove the camera's lens cover, and install the anti-fog film on the camera as shown in figure ①; Open the waterproof housing and place the camera as shown in figure ②.

2. Press the lock up until it locks tightly. Install the waterproof housing on the other accessories, and use the set screw to tighten.

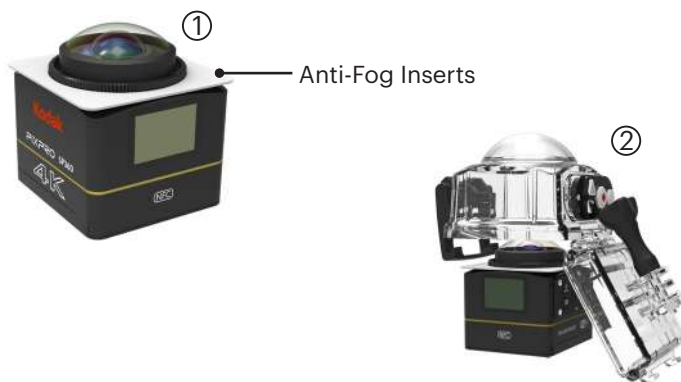

- ① Before using the camera in a wet environment, please be sure to put it inside the waterproof housing first. Also, it should not be submerged to a depth greater than 60 m (196 feet) underwater.
- ② Anti-fog inserts are intended to absorb moisture. Please make sure the insert is dry before using (Heat it in a 100°C oven for around 10 minutes or blow dry it for more than 10 minutes). Each anti-fog insert can be reused up to 3-4 times.
- ③ Before opening the waterproof box, the switch on the lock catch needs to be opened according to the arrow direction firstly.

**Flat Adhesive Mount: For tacking onto a skateboard or other flat objects**



**Curved Adhesive Mount: For tacking onto a helmet or other curved objects**

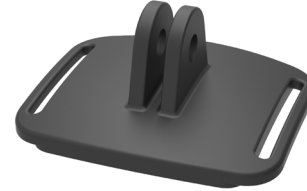

**Installation method:**

There are two types of adhesive mounts: flat and curved. You may select based on the shape of the object to be used.

Both types can be assembled in the same way:

1. Assemble the standard housing (or the waterproof housing) (📖 55/56).
2. Fasten the standard housing (or the waterproof housing), install adhesive mounts according to the diagram, and use the setscrew to tighten.



3. Tack the double-sided adhesive at the bottom of the adhesive mount to the object to be used.

📄 The double-sided adhesive is disposable. It should be replaced by a new one after being peeled off.



**Bar Mount: For mounting on bicycle handlebars, sailing masts, and other tube-like objects**



**Installation method:**

1. Set the bar clamp to the handlebar and rotate the screws to tighten.



2. Assemble the standard housing (or the waterproof housing) (📖 55/56).
3. Assemble the standard housing (or the waterproof housing) and bar clamp in accordance with the direction illustrated in the picture, and use the setscrew to tighten.



## Suction Cup Mount: For attachment to automotive windshields (or smooth surfaces)



Installation method:

1. Assemble the standard housing (or the waterproof housing) (  55/56).
2. Assemble the standard housing (or the waterproof housing), the adapter, pre-tightening nut and suction mount in accordance with the direction illustrated in the picture, and tighten the pre-tightening nut.

3. Clean the suction mount and the windshield before attaching the suction cup to the windshield. Press down the handle to attach it to the windshield.



## Vented Helmet Strap Mount-A: For mounting on hollow objects like bicycle helmets



### Installation method:

1. Align the locator pole on the mount to the locator hole on the camera, and align the screw on the mount to the camera's tripod socket. Turn the screw with a coin or similar shape object to tighten.
2. Spread out the band before threading both ends into the helmet. Thread both ends of the band into the buckle, and then press down on the buckle clamp.

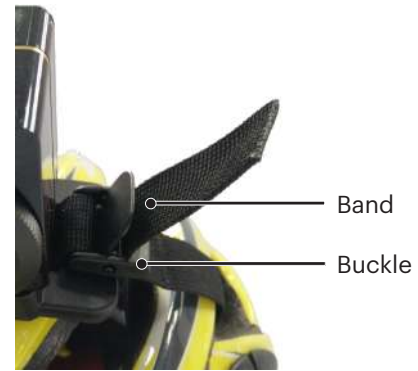

## Vented Helmet Strap Mount-B: For mounting on hollow objects like bicycle helmets



### Installation method:

1. Align the mount's locator hole with the camera's locator hole and align the screw on the mount with the camera's tripod socket. Turn the thumbscrew to tighten.
2. Spread out the band before threading both ends into the helmet. Thread both ends of the band into the buckle, and then press down on the buckle clamp.



## Head Strap Mount: For wearing on one's head



Installation method:

1. Assemble the standard housing (or the waterproof housing) ( 55/56).
2. Insert the base of the standard housing (or the waterproof housing) to the mount before using the setscrew to tighten.



3. Place the band around your head and tighten appropriately.

## Surfboard Adhesive Mount: To be tacked onto watersports equipment like surf boards

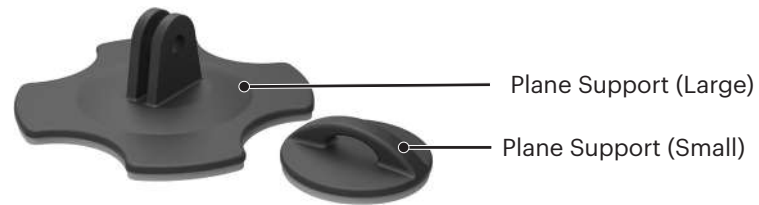

Installation method:

1. Assemble the waterproof housing (📖 56).
2. Assemble the waterproof housing and plane support (large) in accordance with the direction illustrated in the picture, and tighten the setscrew.



3. Tie one end of the rope to the plane support (small), and the other end to the waterproof housing.



4. Tack the double-sided adhesive onto the bottom of the plane support (large) and attach the plane support (small) to the object to be used.

📄 The double-sided adhesive is disposable. It should be replaced with a new one after being peeled off.



**Quick Clip: suitable to be clipped on a belt or harness**



Installation method:

1. Align the locator pole on the quick clip to the locator hole on the camera, and align the screw of the quick clip to the camera tripod-mounting hole, and screw it in to tighten.
2. Clip the clip onto a belt.



**L-type Bracket Adhesive Mount : suitable for sticking on the curved surfaces such as non-porous helmets (with lens upward)**



Installation method:

1. Align the screws on the fixed seat with the mounting holes of the camera tripod, and tighten them.



2. Stick the double-sided adhesive at the bottom of the fixed seat to the objects to be used.

**L-type Bracket Mount : it is used in conjunction with L-type Helmet Adhesive Mount (with lens forward)**



Installation method:

1. Align the screws on the mount with the mounting hole of the camera tripod, and rotate the screws for fixation using a tool like coins.



2. Assembled into L-type helmet adhesive mount as shown in figure, and tighten the screw.



3. Stick the double-sided adhesive at the bottom of the fixed seat to the objects to be used.

## Selfie stick: It needs to be used together with other accessories



 In use, please put it in your hands or mount it on a fixed tripod. Do not use it when your bike or motorcycle has vibrations, shocks, etc.

Installation method:

1. Assemble the standard housing (or the waterproof housing) ( 55/56).
2. Assemble the standard housing (or the waterproof housing) and selfie stick in accordance with the direction indicated in the picture, then tighten the pre-tightening nut.
3. Twist the selfie stick in accordance with the direction indicated in the picture, then draw out, twist reversely and fix the camera.



## Dual Camera Base Mount-A and Remote Control Mount: used together with selfie stick for taking selfies or 360° shooting



 To synchronise the images obtained with the dual camera base mount, it is necessary to disable the EIS function of the camera before photographing. Otherwise, beautiful images cannot be correctly synchronised.

Installation method:

1. Lock one or two SP360 4K cameras on the dual camera base mount. Fasten the clamp, tightly lock the selfie stick and double camera mount with a screw.



2. Install one remote control mount on one side of the handle, put the remote control, which has been matched with SP360 4K camera, on the mount.



3. Tie the rope at the tail end of selfie camera, wrap the rope around your wrist. Draw out the selfie stick to adjust the length.



© 2023 JK Imaging Ltd. All Rights Reserved.

The Kodak trademark, logo and trade dress are used under license from Eastman Kodak Company.

All other logos, products or company names that are referred to in this document are trade names, trademarks or registered trademarks of their holders. The holders are not affiliated with JK Imaging Ltd., our products or our website.

JK Imaging Ltd. 17239 So. Main Street, Gardena, CA 90248 USA

[kodakpixpro.com](http://kodakpixpro.com)

Made in Myanmar

