

KODAK PIXPRO FZ55

DIGITAL CAMERA

User Manual



BEFORE YOU START

Declaration of Conformity

Responsible Party: JK Imaging Ltd.

Address: JK Imaging Ltd., 17239 So. Main Street, Gardena, CA 90248 USA

Company website: kodakpixpro.com

For Customers in the USA

Tested to Comply with FCC Standards FOR HOME OR OFFICE USE

This device complies with part 15 of the FCC Rules. Operation is subject to the following two conditions: (1) This device may not cause harmful interference and (2) this device must accept any interference received, including interference that may cause undesired camera operation.

For Customers in Europe

 "CE" mark indicates that this product complies with the European requirements for safety, health, environment and customer protection. "CE" marked cameras are intended for sales in Europe.

 This symbol [crossed-out wheel bin WEEE Annex IV] indicates separate collection of electrical waste and electronic equipment in the European countries. Please do not throw the equipment into domestic refuse. Please use the return and collection systems available in your country for proper, safe disposal of this product.

 Batteries: Please dispose of used batteries at designated collection centers.

 Packaging: Please follow local regulations for the recycling of packaging.

About this Manual

Thank you for purchasing this KODAK PIXPRO Digital Camera. Please read this manual carefully and keep it in a safe place for future reference.

- JK Imaging Ltd. reserves all rights of this document. No part of this published manual may be reproduced, transmitted, transcribed, stored in a retrieval system or translated into any language or computer language, in any form, by any means, without the prior written permission of JK Imaging Ltd.
- All trademarks mentioned in this manual are used for identification purposes only and are properties of their respective owners.
- This manual provides you with instructions on how to use your new KODAK PIXPRO Digital Camera. Every effort has been made to ensure that the contents of this manual are accurate: however JK Imaging Ltd. reserves the right to make changes without notice.
- Throughout this manual, the following symbols are used to help you locate information quickly and easily:



Indicates useful information.

- The following symbols may be used throughout this manual to facilitate your understanding of how to operate the camera:

[Item properties]: The optional properties in the camera interface are indicated by the [] symbol.

SAFETY NOTES

Safety Notes for this Camera

- Do not drop the camera or allow it to hit solid objects.
- Do not attempt to disassemble or repair the camera.
- Do not use or store the camera in dusty places or on a beach to help prevent dust or sand from entering the camera, causing possible damage.
- Do not use or store the camera in a hot environment or in direct sunlight.
- Do not use or store the camera near powerful magnetic fields, for example near a magnet or transformer.
- Avoid touching the lens of the camera.
- Do not expose the camera to direct sunlight for a long period of time.
- To prevent the camera from being damaged by moisture, do not use or store the camera in very humid environments, such as in rain or near bodies of water.
- If water accidentally comes in contact with the camera, turn the camera off immediately, remove the battery and the memory card and dry it completely within 24 hours.
- When you take the camera from a cold environment to a warmer environment, condensation may occur. Please wait for a reasonable period of time before you turn the camera on.
- Before you remove the battery and memory card, the camera should be turned off.
- When you clean the body of the camera, do not use abrasive, alcohol-based or organic cleansers or solvents.
- Use a professional lens cleaning cloth and appropriate cleaner to wipe and clean the lens.
- Download your photos and remove the memory card when you are going to store the camera for long periods of time.
- If this camera is not in use for a long period of time, please keep it in a dry and clean storage location.
- Our company will not pay compensation for any failure of playback including: pictures or videos damaged or unrecoverable by improper operation.

Safety Notes for Battery

- Please use a battery that is the same type as the one included. Replacement batteries can be purchased at: kodakpixpro.com
- Please use the included charger to charge the battery.
- If battery fluid leaks inside the camera, contact our customer service department immediately. If battery fluid leaks onto your skin, rinse your skin with clean water and seek immediate medical attention.
- Disposal of used batteries should be carried out in accordance with your local (national or regional) regulations.
- To prevent the battery from being damaged, do not drop the battery or allow it to hit solid objects or to be scratched by foreign objects.
- Do not let the battery come in contact with metal objects (including coins) to avoid short circuiting, discharging, excessive heat or possible leakage.
- Do not attempt to disassemble the battery.
- Do not expose the battery to water. Always keep the battery contacts dry.
- Do not heat the battery or throw it into a fire to avoid a possible explosion.
- Do not store the battery in a hot environment or in direct sunlight.
- If the battery overheats during charging or use, stop charging or use immediately. Turn off the product, remove the battery carefully and wait until it cools down.
- When the camera is stored for a long period of time, remove the battery and keep it in a safe, dry place that is not accessible to infants and children.
- In colder environments, the performance of the battery could be noticeably reduced.
- When you install the battery, align the battery markings according to the positive and negative markings inside the camera battery compartment. Never force the battery into the battery compartment.

Safety Notes for Memory Cards

- We highly suggest buying only well-known, name brand memory cards to ensure peak performance and reliability.
- Format the memory card using the camera before you use it or insert a new one.
- Do not drop the memory card or allow it to hit solid objects to avoid damaging it.
- Do not attempt to disassemble or repair the memory card.
- Do not expose the memory card to water. Always keep it dry.
- Do not remove the memory card when the camera is turned on. Otherwise, the memory card and photo/video files could be permanently damaged.
- Do not directly edit the data on the memory card. Copy the data to your computer before you edit files.
- When the camera is stored for long periods of time, be sure to download your photos and remove the memory card. Store the memory card in a dry environment.
- Do not modify the name of the files or folders of the memory card using your computer. Modifying the file names may cause the files to not be recognized on the camera or a possible permanent error may occur.
- A photo taken with the camera will be stored in the folder that is automatically generated on the memory card. Do not store photos that are not taken using this camera in these folders as the pictures cannot be recognized during playback.
- When you insert the memory card, make sure the notch of the card matches the markings on the top of the camera card slot.

Other Safety Notes

- Do not disconnect the power or turn the camera off during the update process. Doing so may cause incorrect data to be written and the camera may not power on later.
- Do not hang the neck or wrist strap of the camera around the neck of a child.
- When using your camera on an airplane, observe the relevant rules specified by the airline and FAA regulations.
- Due to the limitations of manufacturing technology, the LCD may have a few dead or bright pixels. These pixels do no effect the quality or performance of the camera, photos or video.
- Do not expose the camera's LCD to water. In a humid environment, only wipe it with a soft, dry and cleaning cloth.
- If the LCD is damaged and the liquid crystal comes into contact with your skin, wipe your skin with a dry cloth immediately and rinse it with clean water. If liquid crystal comes into contact with your eyes, wash them with clean water at least for 15 minutes and seek immediate medical attention. If you accidentally swallow liquid crystal, rinse your mouth immediately and seek medical attention.

WARNING







- Altering, tampering or modifying the any parts of FZ55 camera is unauthorized and will void the manufacturer's warranty and "could" void Federal and/or State Compliance.
- This equipment has been tested and found to comply with the limits for a Class B digital device, pursuant to part 15 of the FCC Rules. These limits are designed to provide reasonable protection against harmful interference in a residential installation.

This equipment generates, uses, and can radiate radio frequency energy and, if not installed and used in accordance with the instructions, may cause harmful interference to radio communications. However, there is no guarantee that interference will not occur in a particular installation.

If this camera equipment does cause harmful interference to radio or television reception, which can be determined by turning the equipment off and on, the user is encouraged to try to correct the interference by one or more of the following measures:

- Reorient or relocate the receiving antenna
- Increase the separation between the camera equipment and receiver
- Connect the camera equipment into an outlet on a circuit different from that to which the receiver is connected
- Consult the dealer or an experienced radio/TV technician for help

CONTENTS

BEFORE YOU START	1	MODE OVERVIEW	21
SAFETY NOTES	3	Display Setting	21
CONTENTS	8	LCD Screen Display	22
GETTING STARTED	12	Overview of the Screen Icons in Photo Shooting Mode	22
Accessories Included	12	Overview of the Screen Icons in Movie Mode	23
Part Names	13	Overview of the Screen Icons in Playback Mode	24
Installing Battery and Memory Card	14	Using the Mode Button	25
Charging the Battery	16	Auto Mode 	25
Turning Camera On and Off	17	Program AE 	25
How to Take Pictures	18	Manual Mode 	25
Set your Language, Date/Time	18	Movie Mode 	26
Set your Language, Date/Time after the First Power-On	18	Scene Mode 	26
Resetting your Language	19	Panorama Mode 	29
Resetting Date/Time	20	Face Beautifier 	30

BASIC OPERATION..... 31











Using the Zoom Function.....	31
Macro Mode.....	32
Self-timer Setting	33
Flash Mode	34
EV Setting	35
Exposure Compensation	35
ISO	35
Shutter Adjustment.....	36
Aperture Adjustment	36
Using Quick Recording	36













PLAYBACK 37

Viewing Photos and Videos	37
Thumbnail View.....	38
Using Zoom Playback (for still pictures only)	39
Slideshow	40

Photos and Video Deletion	41
---------------------------------	----

USING THE MENUS..... 42

Photo Menu	42
Expo Metering (Exposure Metering) 	42
Image Size 16M	43
Continuous AF 	43
Continuous Shot 	44
Face Beautifier 	44
Focus Setting []	45
HDR 	45
White Balance Setting 	46
Color Effect 	47
Scene 	48
Photo Shoot Settings Menu 	48
Quality	49

AF Assist Beam.....	49	Rotate 	58
Digital Zoom.....	49	Resize 	58
Date Imprint	50	Color 	59
Quick Review.....	50	Playback Settings Menu 	59
Face Detection	50	Protect.....	60
Movie Menu	51	Delete	60
Expo Metering (Exposure Metering) 	51	DPOF (Digital Print Order Format)	61
Video Quality 	52	Trim.....	61
Color Effect 	53	General Settings 	62
Movie Shooting Settings Menu 	53	Sound Settings.....	62
AF Assist Beam.....	54	Power Saver.....	62
Digital Zoom.....	54	Language.....	63
Playback Menu	56	World Time	63
Display Mode 	56	Date & Time	63
HDR 	57	LCD Brightness.....	63
Touch-up 	57	Connection Settings 	64

Connecting to a Computer	65
Connecting to PICTBRIDGE™ Compatible Printers	66
Using the PICTBRIDGE™ Menu	68
File Settings 	71
Format	72
Copy to Card.....	72
File Numbering.....	73
Reset.....	73
Firmware (FW) Version	73
APPENDICES	74
Specifications.....	74
Prompts and Warning Messages	78
Troubleshooting	82
Memory Card Compatibility	84

GETTING STARTED

Accessories Included

Your camera box should contain the camera model you purchased along with the following accessories. If anything is missing or appears to be damaged, please contact your retailer first or our customer service center. (The battery chargers may be a little different in shape due to the difference of countries or regions this type of camera is sold to, and is subject to matching the physical product).

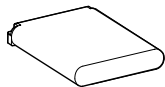

Rechargeable Li-ion Battery

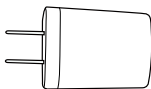

AC Adapter

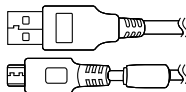

Micro USB Cable



Wrist Strap



Quick Start Guide



Warranty Card



Service Card

Part Names

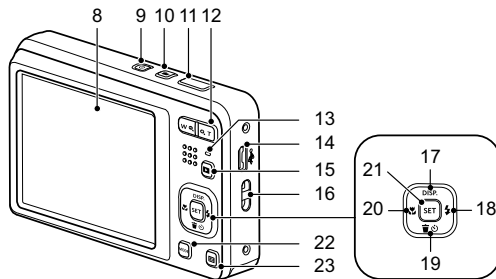
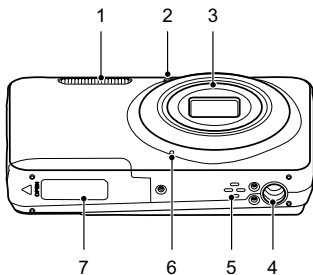

- | | | |
|--------------------------------------|---------------------------------|---|
| 1 Flash Lamp | 8 LCD | 16 Strap Eyelet |
| 2 AF Assist Beam/
Self-timer Lamp | 9 Power Button | 17 [▲ DISP.] Display Button/Arrow Button (Up) |
| 3 Lens | 10 Quick Video Recording Button | 18 [►⚡] Flash Button/Arrow Button (Right) |
| 4 Tripod Socket | 11 Shutter Button | 19 [▼🗑️🕒] Delete Button/Self-timer Button/
Arrow Button (Down) |
| 5 Speaker | 12 Zoom Button | 20 [◀️🌸] Macro Button/Arrow Button (Left) |
| 6 Microphone | 13 Indicator Lamp | 21 SET Button |
| 7 Battery Cover | 14 Micro USB Port | 22 Mode Button |
| | 15 Playback Button | 23 Menu Button |

Installing Battery and Memory Card

1. Open the battery cover door.

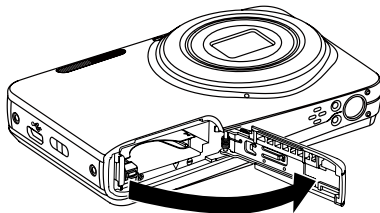
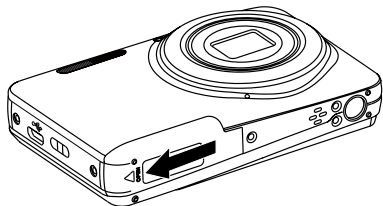

2. Insert the battery into the battery slot in the correct direction as shown in the following diagram.

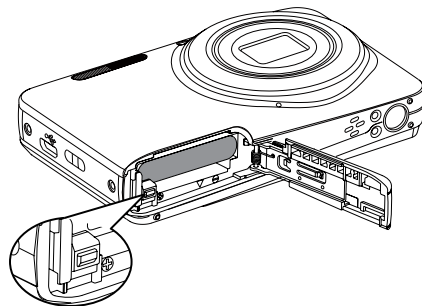
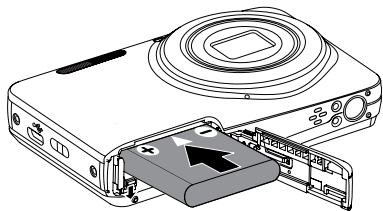

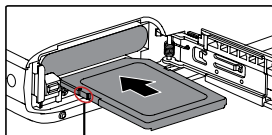

3. Insert the memory card into the memory card slot as shown in the diagram below:

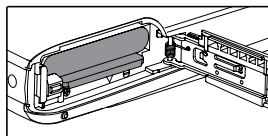

Write Protection Toggle Switch



 A memory card (SD/SDHC/SDXC) is optional and not included in all camera packaging. It needs to be purchased separately. Please use an original memory card which is Class 10 or higher and has a capacity of 4GB to 512GB.

 To remove your memory card, open the battery cover door, gently press the memory card to eject it and remove it carefully.

4. Close the battery cover door.

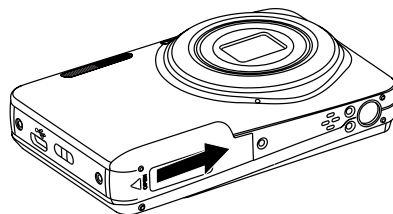
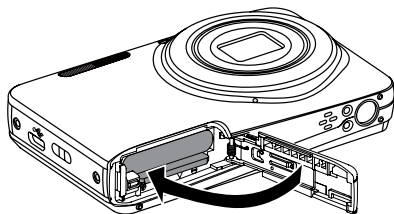





Charging the Battery

Before you charge your battery, you should turn the camera off and insert the battery.

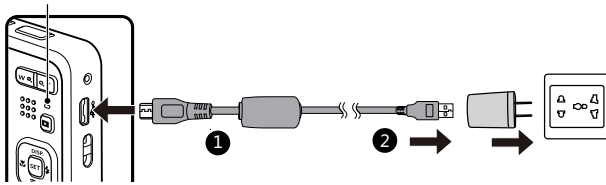
1. Connect the camera to the power charger using the supplied USB cable.
2. Insert the plug of the power charger into the wall outlet to charge the battery.

Indicator Lamp



-  The charger is for indoor use only.
-  After the battery is stored for long periods of time, use the supplied power charger to fully charge the battery prior to use.
-  Charging Indicator:
Steady orange: Charging
The indicator lamp will go out once charging is finished and the camera will power off automatically. To maximize battery life, we strongly recommend charging the battery for at least 4 hours the first time.

-
-  When the camera is turned off, you can also connect the camera to your PC using a USB cable to charge the battery.

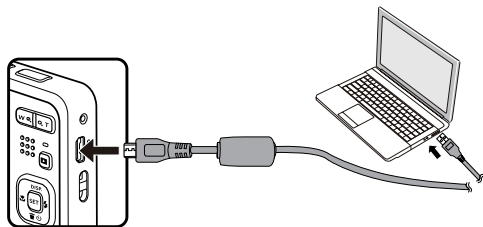

-  Please charge the battery indoors between 0°C and 40°C (32°F and 104°F).

Turning Camera On and Off

Press the Power button to turn the camera on. To turn the camera off, press the Power button again.

Power Button

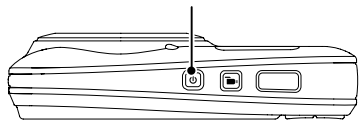











-  When the power is off, press and hold the play  button to power on and enter Playback mode.

How to Take Pictures

1. Hold the camera with both hands, being careful to not block the flash and lens with fingers.
2. Point the lens toward the object you want to take a picture of, and then frame it with the LCD.
3. Use the Zoom button to select Tele or Wide positions to zoom in or out on your subject.
4. Press the shutter button halfway down to focus on the subject. When the focus frame turns green, press the shutter button all the way down to completely to take the picture.

































Set your Language, Date/Time

Set your Language, Date/Time after the First Power-On

1. When you turn the camera on for the first time, the language selection screen appears.
2. Press the arrow buttons to select your desired language.
3. After you press the  button to confirm your language selection, the Date/Time settings screen will appear.
4. Press the [ ]/[ ] buttons to select the Date/Time to be adjusted: This information is displayed in YYYY.MM.DD/HH:MM.
5. Press the [ DISP.]/[  ] buttons to adjust the value for the desired Date/Time.
6. Press the  button to confirm the time settings and the snapshot screen will appear.

Resetting your Language





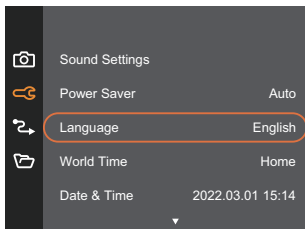

















After you set your language for the first time, follow the instructions below to reset your desired language.

1. Press the [] button and press the [ DISP.]/[  ] buttons to select []. Press the [] button to enter the menu.
2. Press the [ DISP.]/[  ] buttons to select  , and press the [] / [ ] button to enter the menu.
3. Press the [ DISP.]/[  ] buttons to select [Language] and press the [] / [ ] button to enter the menu.
4. Press the [ DISP.]/[  ]/[ ]/[ ] buttons to select your desired language and press the [] button to confirm.
5. Press the [] button and the snapshot screen will appear.









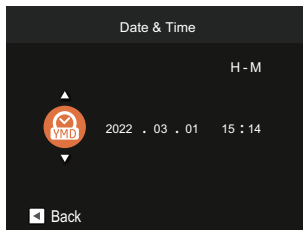
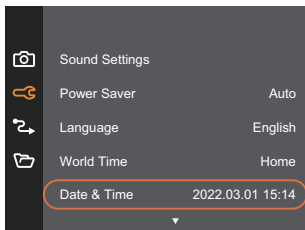



Resetting Date/Time

After you set your Date/Time for the first time, follow the instructions below to reset date and time.

1. Press the [] button and press the [ DISP.]/[  ] buttons to select . Press the [] button to enter the menu.
2. Press the [ DISP.]/[  ] buttons to select , and press the [] / [ ] button to enter the menu.
3. Press the [ DISP.]/[  ] buttons to select [Date & Time] and press the [] / [ ] button to enter the menu.



4. Press the [ ]/[ ] buttons to select the Date/Time to be adjusted: This information is displayed in YYYY.MM.DD/HH:MM.
5. Press the [ DISP.]/[  ] buttons to press the value for your selected entry. After you finish your settings, press the [] button to confirm.
6. Press the [] button and the following snapshot screen will appear.

MODE OVERVIEW

Display Setting

Press the [▲ DISP.] button to display the settings: Classic, Full, Off.

Classic: Displays the camera parameters on screen

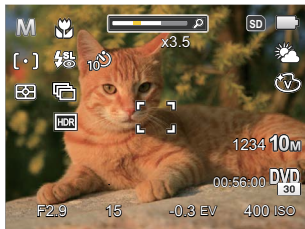

Full: Camera parameters with Grid and Histogram

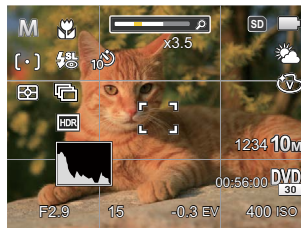

Off: Does not display any additional icons on screen

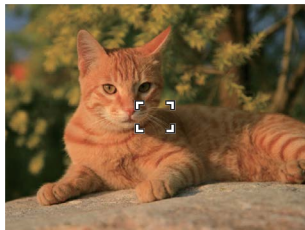

LCD Screen Display

Overview of the Screen Icons in Photo Shooting Mode

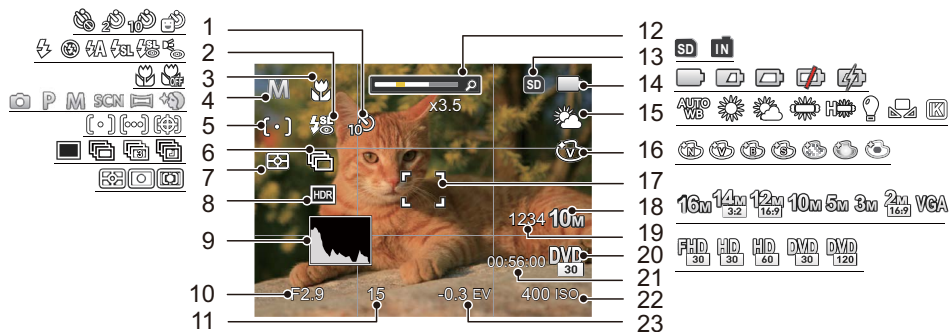

- | | | |
|-------------------|--------------------------------|-------------------------------------|
| 1 Self-timer | 9 Histogram | 17 Focus Frame |
| 2 Flash Mode | 10 Aperture | 18 Image Size |
| 3 Macro Mode | 11 Shutter Speed | 19 Number of Remaining Shots |
| 4 Shooting Mode | 12 Zoom Display | 20 Video Quality |
| 5 AF Mode | 13 Memory Card/Built-In Memory | 21 Remaining Recording Time |
| 6 Continuous Shot | 14 Battery Status | 22 ISO Value |
| 7 Expo Metering | 15 White Balance | 23 Exposure Compensation (EV Value) |
| 8 HDR | 16 Color Effect | |

Overview of the Screen Icons in Movie Mode

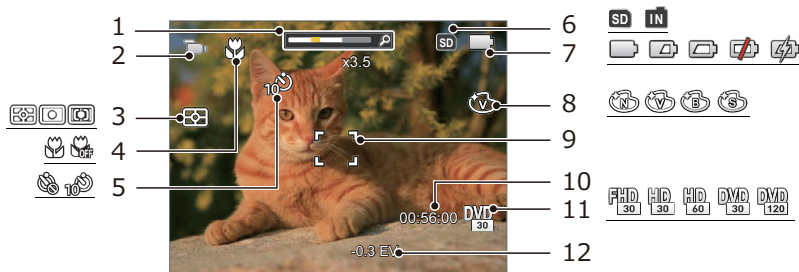

- | | | |
|-----------------|-------------------------------|-------------------------------------|
| 1 Zoom Display | 5 Self-timer | 9 Focus Frame |
| 2 Movie Mode | 6 Memory Card/Built-In Memory | 10 Remaining Recording Time |
| 3 Expo Metering | 7 Battery Status | 11 Video Quality |
| 4 Macro Mode | 8 Color Effect | 12 Exposure Compensation (EV Value) |

 For optimal video recording, it is recommended that an SDHC or SDXC memory card be used.



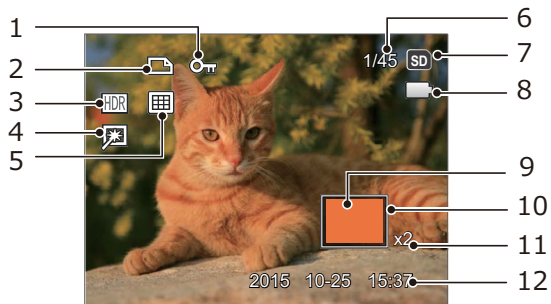

 Optical Zoom and Digital Zoom can be adjusted (30X in total). Digital Zoom can be adjusted to 6X.

Overview of the Screen Icons in Playback Mode



- | | | | |
|---|---|----|-----------------------------|
| 1 | File Protection | 7 | Memory Card/Built-in Memory |
| 2 | DPOF File | 8 | Battery Status |
| 3 | HDR | 9 | Zoom Magnification Area |
| 4 | Touch-up | 10 | Image Zone |
| 5 | Display Mode | 11 | Image Zoom Ratios |
| 6 | Memory space (indicating the current number of photos and total number of photos) | 12 | Shooting Date |

Using the Mode Button

This camera provides a convenient Mode button  that allows you to switch easily between different modes. After pressing the Mode button  to enter the Mode Selection Menu, press the []/[] button to choose the desired mode. Press the  button to confirm your selection.



Auto Mode

Auto Mode is the most common and easiest mode to take photos. While operating in this mode, the camera automatically optimizes numerous camera settings to optimally adjust settings for your photos and videos for the best possible results.

Program AE

The user can switch the ISO and EV value according to personal preference, the camera can automatically set the shutter speed and aperture value.



Manual Mode

The user can adjust the aperture, shutter speed and ISO values manually. This setting is generally used to shoot static photos.

Movie Mode

Switch to this mode to record videos.

Scene Mode

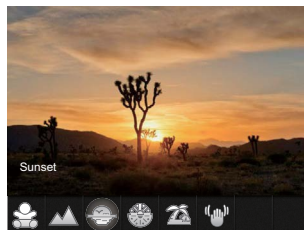
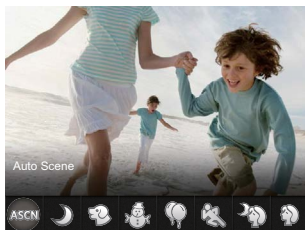

You can press the []/[] button to select your desired scene from the 14 preset modes according to the type of environment you are shooting in, and press the  button to confirm your selection. The camera then automatically configures the most appropriate settings for the best possible photos.







ASCN

The camera can intelligently detect different environments and automatically select the best scene and photo settings for you.

ASCN can intelligently detect the following scenes:

-  Auto Mode The camera automatically adjusts the exposure and focus to ensure the best possible pictures.
-  Landscape Mode For landscapes, automatically adjusts the exposure and reproduces vivid green and blue colors.

-
- | | | |
|---|-----------------------------|---|
|  | Backlit Portrait | When the sun or any other light source is behind the target you want to shoot, this mode automatically adjusts the foreground exposure to produce the best pictures possible. |
|  | Macro Mode | The macro setting is ideal for shooting small objects or extreme close-up photos. |
|  | Night Landscape Mode | For night scenes, this mode automatically increases the ISO value to compensate for low light. |
|  | Portrait Mode | Most suitable for capturing people with focus on their faces. |
|  | Night Portrait | When you take portraits at night, or in low light conditions, this mode automatically adjusts the exposure for people and night scenes. |

Night Landscape

For night scenes. Use of a tripod or a flat surface to rest the camera on is recommended with this setting.

Pet Mode

The camera automatically takes a picture when a dog or cat face is detected.

Snow

For snowy conditions. Reproduces natural, clear, white scenes.

Party

Suitable for taking indoor party pictures, even under complicated lighting conditions.

Sport

For fast-moving subjects. Captures sharp, action shots with minimal blur. This mode is not recommended for shooting indoors.

Night Portrait

For portraits against night scenery.

Portrait

The camera is set to automatically adjust exposure for realistic capture of skin tones.

Children

Turns flash off automatically. Avoids disturbing the subject and is suitable for taking photos of children.

Landscape

For landscapes and outdoor shots. Vivid reproduction of greens and blues.

Sunset

For sunsets. Captures subjects in strong sunlight.

Fireworks

For fireworks at night. Use of a tripod or a flat surface to rest the camera on is recommended with this setting.

Beach

For portraits against night scenery.

Anti-shake



This mode can help reduce photo blur caused by hand shake, low light and/or slow shutter speed.

Panorama Mode

With Panorama Mode, you can take a series of pictures which will be automatically stitched into an ultra-wide panoramic (up to 180°) picture by the camera.

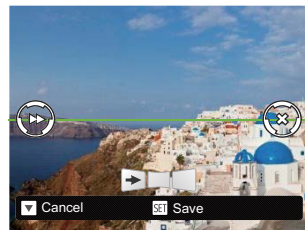



1. Press the arrow buttons to select a desired shooting direction. Should you not select a direction, the default shooting direction is “left to right”. 2 seconds later, the camera will be ready to take pictures. You can also press the  button or press the shutter button halfway down to get ready to take panoramic pictures.
2. Compose the first view of the panoramic picture on the LCD and press the Shutter button to capture the image.
3. When you finish shooting the first photo, two target icons will display on the LCD at left and right sides. Move the camera to the right until the round target icon is directly positioned over the square box. The box will turn green when they overlap and the camera will automatically take the next picture. Repeat the same steps for additional shots. Up to 4 frames can be stitched together.



4. If continuous pictures are less than 4 shots, press the  button, the camera will automatically stitch the pictures together. Press the Playback button to enter Playback Mode to see the finished effect.
 5. If you take 4 pictures, the camera will stitch the pictures together automatically. Press the Playback button to enter Playback Mode to see the finished effect.
-  In Panorama Mode, the Flash, Self-timer, Macro Modes and Exposure Compensation are not available. Focus Adjustment is also not available at this time.
 -  In Panorama Mode, up to 4 photos can be captured when the image size is set at 2M.





 In the process of shooting in Panorama Mode, when the LCD shows “Improper alignment. Please try again”, it means that in the process of the camera moving, the angle is off the green line and stitching cannot be completed. You will have to try again, keeping the LCD image aligned with the green line.





 In order to guarantee the best shooting effect in Panorama Mode, please keep moving horizontally and keep unnecessary shaking to a minimum.

 During Panorama Mode shooting, press the  button to interrupt shooting and save the current pictures. Press the [  ] button to cancel shooting and delete previously taken pictures.

Face Beautifier

This mode automatically enhances facial features with skin softening touches and eye brightening capabilities.

Please refer to the table below if any nonadjustable options in  P M  SCN   mode: (O: Available X: Not available)

Options Mode	Aperture	Shutter	EV	ISO
	X	X	X	X
P	X	X	O	O
M	O	O	X	O
	X	X	O	X
SCN	X	X	X	X
	X	X	X	X
	X	X	O	O

BASIC OPERATION

Using the Zoom Function

Your camera is equipped with two types of Zoom Functions: Optical Zoom and Digital Zoom. Press the Zoom button of the camera to zoom in or out on the subject while taking pictures.

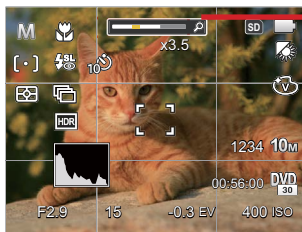
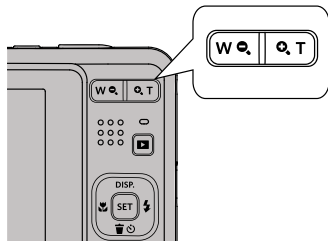

Zoom Indicator





When the optical zoom reaches the threshold as digital zoom, release and turn the zoom button to T to switch between the optical zoom and digital zoom.

Macro Mode

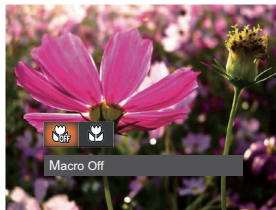
The Macro Setting is ideal for shooting small objects or close-up photos. This mode allows you to focus on subjects very close to the camera.



1. Press the [] button to enter the Macro Menu.







2. Press the []/[] buttons to select the following 2 modes:
 -  Macro Off
Select this option to disable Macro.
 -  Macro On
Select this option to focus on subjects 5cm from the lens.
3. Press the  button to confirm the settings and exit the menu.

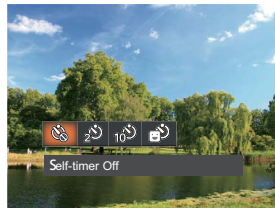
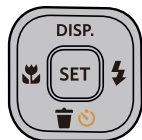

Self-timer Setting

Use this function to take pictures at pre-set intervals. The camera shutter speed can be set to 2 seconds, 10 seconds or Smile Detection.

1. Press the [  ] button to enter the Self-timer Menu.









2. Press the [ ]/[ ] buttons to select one of the following 4 modes:

-  Self-timer Off
Disables the Self-timer.
-  Self-timer 2sec
A single picture is shot 2 seconds after the Shutter Button is pressed.
-  Self-timer 10sec
A single picture is shot 10 seconds after the Shutter Button is pressed.

-  Self-timer Smile
Press the Shutter Button and a picture will be taken immediately after a smile is detected.

3. Press the  button to confirm the settings and exit the menu.

 When enabling the Self-timer feature, pressing the shutter or the [  ] button can disable the Self-timer and return to the shooting screen without keeping the Self-timer setting.



 When enabling smile detection, pressing the shutter button or the  button can disable the Self-timer and return to the shooting screen without keeping the Self-timer Smile Setting.



Flash Mode

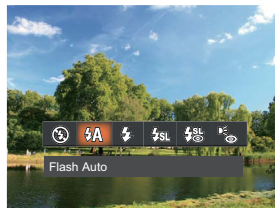
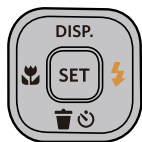



The flash provides supplemental light for scenes. The flash is usually used when shooting against the light to highlight the object; it is also suitable for metering and shooting in darker scenes to improve the exposure.

1. Press the [] button to enter the Flash Settings Menu.



2. Press the []/[] buttons to select one of the following 6 modes:



-  Force Off
Flash is turned off.
-  Flash Auto
Camera flash goes off automatically based on lighting conditions.
-  Force Flash
The flash will engage with each shot even if there is enough available light to take the photo without flash.

-  Slow Sync.
This allows you to take pictures of people at night that clearly show both your subjects and the night time backdrop. The use of a tripod is recommended when shooting with this setting.
 -  Slow Sync. +Red-Eye
Use this mode for slow synchro shots with red-eye reduction.
 -  Red-Eye Reduction
The camera emits a brief pre-flash before the picture is taken to reduce red-eye effects.
3. Press the  button to confirm the settings and exit this option.





EV Setting

The EV Function Menu of the camera includes functions, such as EV, Shutter Adjustment and ISO. Using the appropriate Function Settings can improve your pictures.

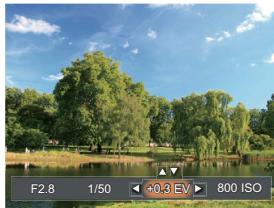
To select the best setting for optimum photos, follow these steps:

1. Press the  button to display the Settings screen.
2. Press the []/[] buttons to select the Setting options.



3. Press the [] [DISP.]/[] [] [] buttons to adjust the option values.
4. Press the  button to complete the setting and enter Shooting Mode.

Exposure Compensation

Set up Exposure Compensation to adjust the picture brightness. If there is very high contrast between the photographed object and the background, the brightness of the picture can be adjusted as necessary.

The adjustable range of exposure value is from EV -3.0 to EV+3.0.

ISO

The ISO Function allows you to set the sensitivity of the camera's light sensor based on the brightness of the scene. To improve the camera's sensor performance in darker environments, a higher ISO value is required. A lower ISO value is needed when shooting in brighter conditions.

Pictures taken at higher ISO settings will generally have more noise than those taken at lower ISO settings. The camera's ISO settings include: Auto, 100, 200, 400, 800, 1600 and 3200.

Shutter Adjustment

For shutter speed, the camera may automatically set the aperture value corresponding to the manually set shutter speed to obtain the most suitable exposure value. The movement of objects may be shown by adjusting the shutter speed. High shutter value can help you more clearly capture fast moving objects, while low shutter value can better show the movement of objects.

Aperture Adjustment

You can adjust the aperture size value. Selecting a large aperture opening will emphasize the point of focus and show a blurry background and foreground. A small aperture opening will keep both the background and main object in clear focus.

Using Quick Recording

In the Photo Shooting Mode, press the Fast Video Recording Button  to begin recording video.

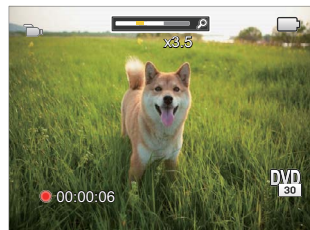





Once you are finished, press the Fast Video Recording Button  or the Shutter Button to stop and store the video. The camera will return to the Shooting Mode automatically.

PLAYBACK

Viewing Photos and Videos

To view captured photos and video clips on the LCD:

1. After pressing the  button, the last photo or video clip taken will be displayed on the LCD.
2. Use the []/[] buttons to scroll through the photos or video clips stored on the built-in memory or on the Memory Card in the camera.
3. To play a selected video clip, press the  button to enter the Movie Playback Mode.

An operation guide appears on the screen when playing back a video. Press the appropriate buttons to enable the corresponding functions.

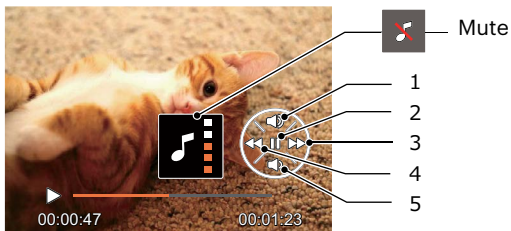

1	Increase Volume
2	Pause
3	Fast Forward
4	Rewind
5	Decrease Volume

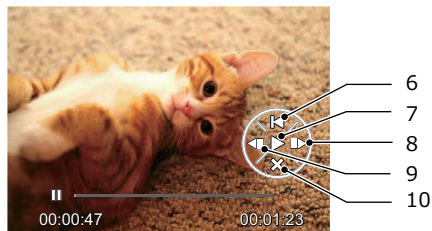

6	Return back to the beginning of the video
7	Play
8	Frame Forward
9	Frame Backward
10	Cancel Playback

Thumbnail View

When in Playback Mode, press the **W**  on the Zoom button to display thumbnail images of photos and videos on the screen.



1. Slide the Zoom button to switch between 3 x 3 and 4 x 4 thumbnails.
2. When a 3 x 3 or 4 x 4 thumbnail is displayed, press the arrow buttons to select the picture or video clip to view.

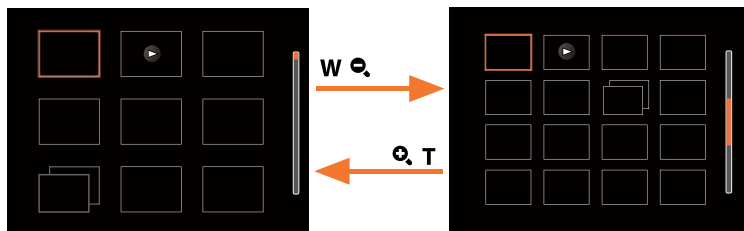

3. Press the arrow buttons to select a picture or video clip to view and press the **SET** button to restore it to the original size.



If the  indicator appears on the LCD, then a movie file is currently being displayed.



Press the **SET** button to restore a preview icon to its original image size.

Using Zoom Playback (for still pictures only)

When playing back photos, you can also use the Zoom Button to zoom in on the photos, 2 to 8 times their original magnification.



1. Press the [◀⏪]/[▶⏩] buttons to select the picture on which to use the zoom feature.
2. Press the **T** on the Zoom Button to zoom in.
3. The bottom right corner of the screen will display the amount zoomed in as well as the area of the photo shown.

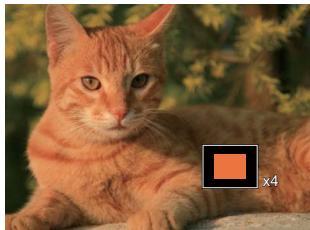





4. Press the arrow buttons to navigate and select the desired portion of the photo to be zoomed in on.
5. Press the button to return the image to its original scale.

- Movie images cannot be magnified.
- Please note: This camera's LCD is only capable of displaying a fraction of the detail and resolution of the actual photo or video file. Once photos/videos are downloaded to your computer, you will see the full resolution of the photo/video file captured.

Slideshow

This setting allows you to view all the stored pictures as a slideshow.

1. Press the  button to enter playback screen.
2. Press the  button to enter slide option.
3. Press the []/[] buttons to select slideshow playing or [Cancel] to return to the playback screen.

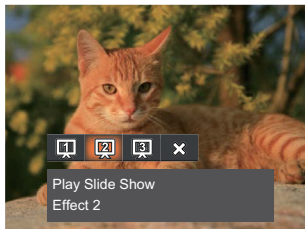

- Play Slide Show
 - Effect 1
 - Play Slide Show
 - Effect 2
 - Play Slide Show
 - Effect 3
4. Press the  button to confirm the setting.

Photos and Video Deletion

In Playback Mode, press the [▼🗑️🕒] button to select your desired photos and videos.

To delete photos or videos:

1. Press the [📺] button to switch to Playback Mode.
2. Press the [◀️🗑️]/[▶️🗑️] buttons to select the photos and videos to be deleted.
3. Press the [▼🗑️🕒] button and the deletion screen is displayed.

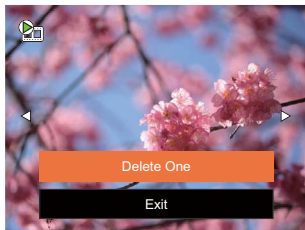

4. Press the [▲ DISP.]/[▼🗑️🕒] buttons to select [Delete One] or [Exit] and press the [SET] button to confirm.



Erased photos/video clips cannot be recovered.









Please refer to 59 for instructions on deleting more than one image at a time.

USING THE MENUS

Photo Menu

Mode:  **P** **M** **SCN**  

1. In Photo Shooting Mode, press the  button to enter the Photo Shooting Menu.
2. Press the [▲ DISP.]/[▼  ] buttons to select the Photo Shooting Menu and settings.
3. Press the [◀ ]/[▶ ] buttons to select the Photo Shooting Menu to be set and press the  button to confirm.

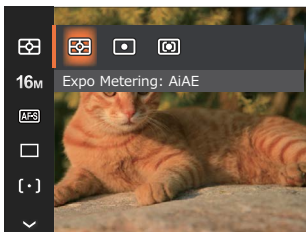

Expo Metering (Exposure Metering)

Use this setting to select the “target” size of the camera’s field of view to be metered.

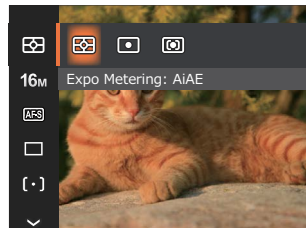

- **AiAE (Artificial Intelligence AE)** Automatically selects the central and peripheral metering, to calculate the reasonable value of metering by weighting.
- **Spot** Metering targets a small area in the center of the camera’s field of view.
- **Center** Metering targets a slightly larger area in the center of the camera’s field of view.

Image Size 16M

The size setting refers to the image resolution in pixels. A higher image resolution allows you to print that image in larger sizes without degrading the photo image quality.

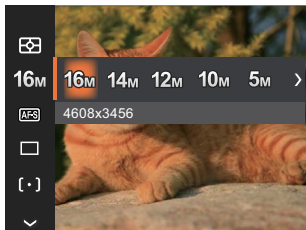

- 16M: 4608x3456
- 14M: 4608x3072 (3:2)
- 12M: 4608x2592 (16:9)
- 10M: 3648x2736
- 5M: 2592x1944
- 3M: 2048x1536
- 2M: 1920x1080 (16:9)
- VGA: 640x480



The bigger the number of recorded pixels is, the better the image quality becomes. As the number of recorded pixels lessens, you will be able to record more images on a memory card.

Continuous AF **AFS**

Use the Continuous AF setting to be able to continuously focus automatically when taking pictures.

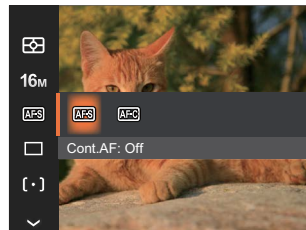



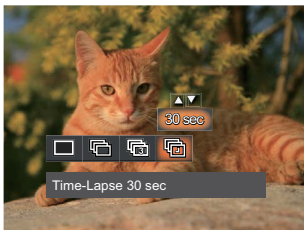

- Cont.AF: Off
- Cont.AF: On

Continuous Shot

Use this setting to perform continuous shooting. After entering this mode, you can shoot multiple images by continuously holding the shutter button down.







-  Single
-  Continuous Shot
-  3 Shots
-  Time-Lapse (30sec/1min/5min/10min)

 The flash is disabled in Continuous Shot Mode in order to achieve quick succession of shots.

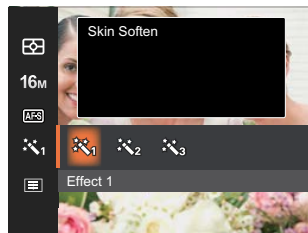
 Press the shutter button to start continuous shooting.

Face Beautifier



-  Effect 1
Skin Soften
-  Effect 2
Skin Soften + Eye Brightening
-  Effect 3
Skin Soften + Eye Brightening +
Eye Enlargement

Focus Setting [○]

This setting allows you to select different modes for optimum focus.

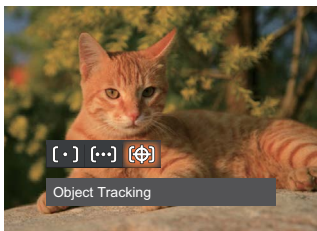

- [○] Single-AF
The focus frame appears on the center of the LCD to help you focus on the subject.
- [○○] Multi-AF
The camera automatically focuses the subject in a wider area to find the focal point.
- [📷] Object Tracking
Smart tracking of the object in motion under the focusing shooting.

When [📷] is enabled, Object Tracking function is not available.

HDR [HDR]

Use this setting to control wide dynamic image range when taking static pictures. Photos with extreme contrast of bright and dark areas will still maintain distinguishable detail and depth. (Suggest using tripod)

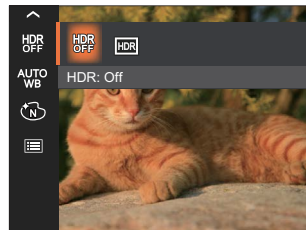







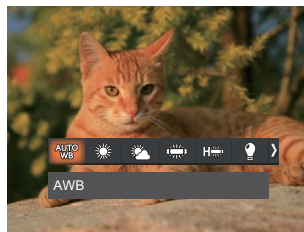
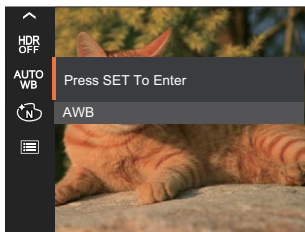

- HDR: Off
- HDR: On

[📷] In the scenario with high light contrast (too dark or too light), this function can be used to shoot satisfactory photos.

White Balance Setting AUTO WB

The white balance setting allows you to adjust the color temperature for different lighting scenes to ensure the most accurate color reproduction.









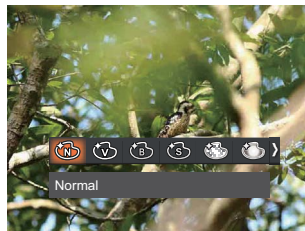
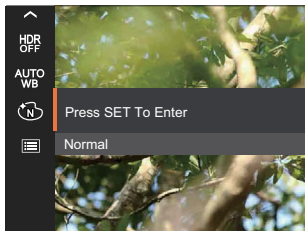

- AUTO WB AWB
-  Daylight
-  Cloudy
-  Fluorescent
-  Fluorescent CWF
-  Incandescent
-  Manual WB
(Fully press the Shutter Button to detect the white balance value)
-  Color Temp. (1900K-10000K)
Press the [▲ DISP.]/[▼ ⏻] buttons to “Adjust the K value”; Press the [◀ 🌿] button to exit the K value.

Color Effect

The image color setting allows you to select different color effects.







-  Normal
-  Vivid
-  Black and White
-  Sepia
-  Dreamy
-  Vignetting
-  Salon

 When HDR or Continuous Shot function is enabled, Dreamy, Vignetting and Salon is not display.

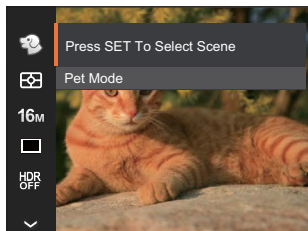
Scene

Select a scene under Scene Mode (**SCN**). Refer to the “Scene Mode” section on page 26.



In  mode, you can press the [  ] button on the shooting screen to set up Auto shooting.

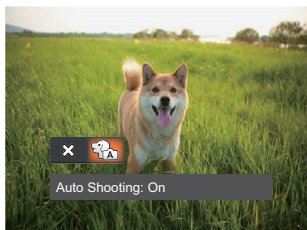
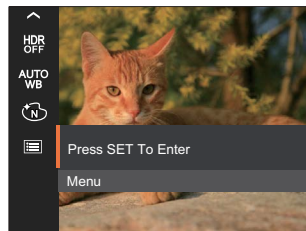

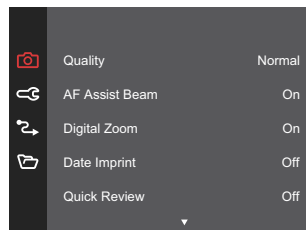

Photo Shoot Settings Menu



Press the  button to enter the menu.



Quality

The quality setting can be used to adjust the image compression ratio.

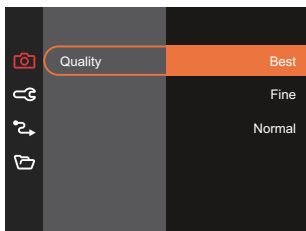

- Best 16M Average File Size: 4.0MB
- Fine 16M Average File Size: 2.5MB
- Normal 16M Average File Size: 2.0MB

AF Assist Beam

In a darker environment, the AF assist beam setting can be turned on for better focus.

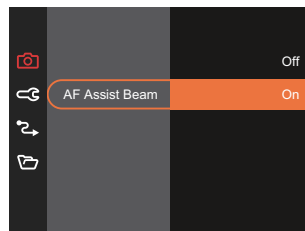

Digital Zoom

This setting is for adjusting digital zoom. If this function is disabled, only optical zoom can be used.

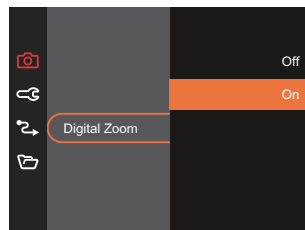

Date Imprint

Include a Date/Time stamp on the photo image.

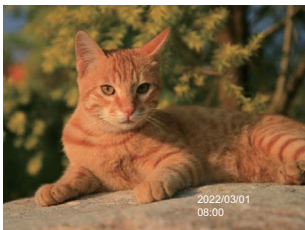
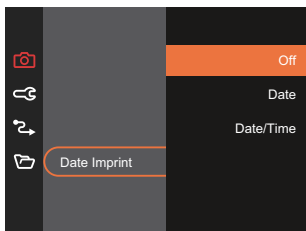

Quick Review

This option allows quick review of the photos immediately after they are taken. Each photo is displayed on the LCD screen based on the selected time.

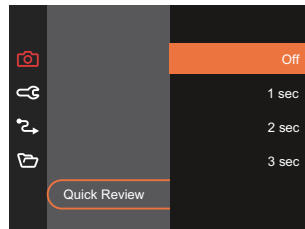



Face Detection

Detects and focuses on faces to make all faces as clear as possible in Photo Mode.



Movie Menu

Mode: 

1. Press the  button, select the  mode and press the  button to enter the Movie Menu.

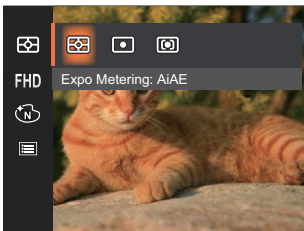

2. Press the [▲ DISP.]/[▼🗑️🕒] buttons to select the Movie Menu to be set.
3. Press the [◀️👁️]/[▶️⚡] buttons to select the Movie Menu to be set and press the  button to confirm.

Expo Metering (Exposure Metering)

Use this setting to select the “target” size of the camera’s field of view to be metered.

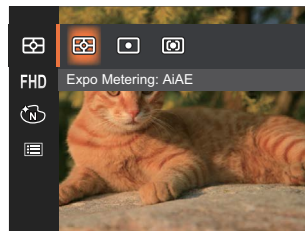

- AiAE (Artificial Intelligence AE) Automatically selects the central and peripheral metering, to calculate the reasonable value of metering by weighting.
- Spot Metering targets a small area in the center of the camera’s field of view.
- Center Metering targets a slightly larger area in the center of the camera’s field of view.

Video Quality FHD

Set the image resolution used during video recording.

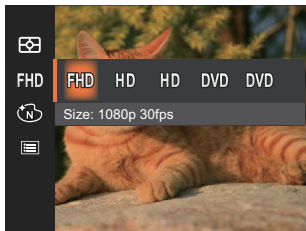

The speed requirements for reading and writing high resolution image pixel images to an SD card are as follows:





No.	Image Pixels	Frames	Recommendation	Recording Time (4GB) About
1	1920x1080*	30	Class 10	13 Minutes
2	1280x720	60	Class 10	14 Minutes
3	1280x720	30	Class 10	29 Minutes
4	640x480	30	Class 10	84 Minutes
5	640x480	120	Class 10	22 Minutes

- * The longest recording time is 29 minutes at one time.
- When recording in higher pixel resolutions for extended periods of time, this can cause the camera to generate heat. This is not a camera malfunction.
- Sound recording is disabled when 640x480 120fps is chosen.
- When the video format is set as 640x480 (120fps), the shooting time is 30 seconds and the playback time is 2 minutes.

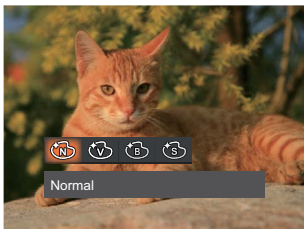
Color Effect

The Image Color Setting allows you to select different color effects.



-  Normal
-  Vivid
-  Black and White
-  Sepia

Movie Shooting Settings Menu

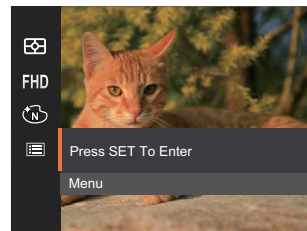

Press the  button to enter the menu.

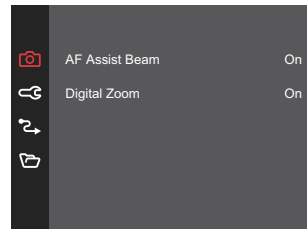

AF Assist Beam

In a darker environment, the AF assist beam setting can be turned on for better focus.

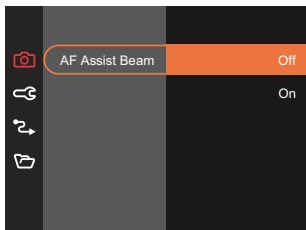

Digital Zoom

This setting is for adjusting digital zoom. If this function is disabled, only optical zoom can be used.

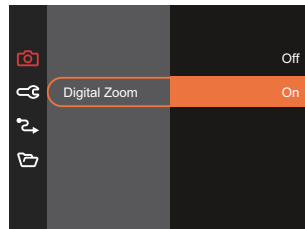



Options in the shooting mode (O: Available X: Unavailable)









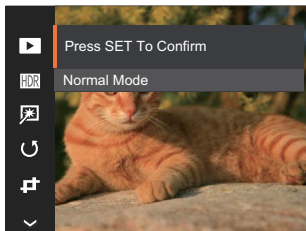





Options	Shooting Modes												
		P	M		SCN								
					ASCN						Others		
	O	O	O	O	O	O	O	O	O	O	X	O	
16M	O	O	O	X	O	O	O	O	O	O	X	O	
FHD	X	X	X	O	X	X	X	X	X	X	X	X	
AF-S	O	O	O	X	X	X	O	X	X	X	X	O	
	O	O	O	X	X	X	O	X	X	O	X	X	
	X	X	X	X	X	X	X	X	X	X	X	O	
(·)	O	O	O	X	X	X	X	X	X	X	X	X	
HDR	O	O	O	X	X	O	O	X	O	X	X	X	
AUTO WB	X	O	O	X	X	X	X	X	X	X	X	X	
	X	O	O	O	X	X	X	X	X	X	X	X	
	O	O	O	O	O	O	O	O	O	O	O	O	

Playback Menu

Mode: 



1. Press the  button to display the playback screen and press the  button to enter the menu.

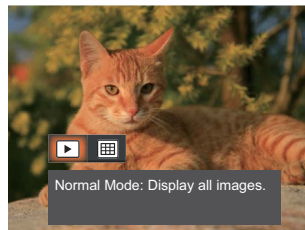

2. Press the [ ▲ DISP.]/[ ▼  ] buttons to select the playback desired and press the  button to enter.
3. Press the [ ▲ DISP.]/[ ▼  ] or [ ◀ ]/[ ◀  ▶ ] buttons to select an option and press the  button to confirm.

Display Mode



-  Normal Mode: Display all images.
-  Date Mode: Arranged by date.





The Date Folder is displayed in date order based on photo shooting date/time.

HDR

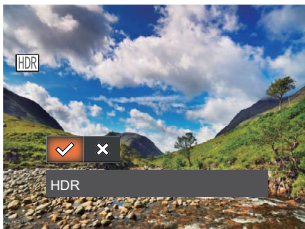
With the HDR function, pictures that are overexposed may be corrected to optimize the highlights and lowlights captured to more accurately represent the actual scene.







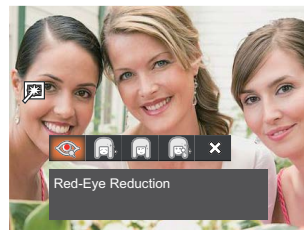

-  HDR
-  Cancel

 After using the HDR function, the image will be saved as a new file and the original file is still stored on the memory card.

Touch-up

The playback beauty feature allows for beautification using three individual effects.





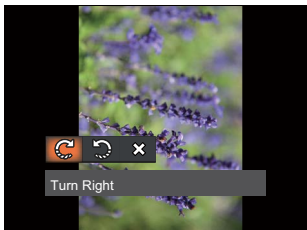

-  Red-Eye Reduction
-  Skin Soften
-  Eye Brightening
-  Eye Enlargement
-  Cancel

Rotate

You can use this setting to change the orientation of the picture.



-  Turn Right
-  Turn Left
-  Cancel



 Videos and panoramic pictures cannot be rotated.

 The rotated picture file will replace the original photo.

Resize

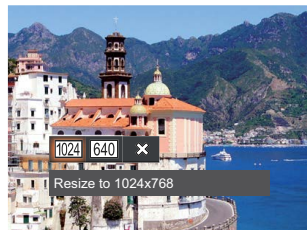
This setting allows you to resize a picture to a particular resolution and saves it as a new picture.



-  Resize to 1024x768
-  Resize to 640x480
-  Cancel

 Only for adjusting pictures with high resolution to those with a lower resolution.

 Sizes of photos taken in panorama mode or rotated cannot be adjusted.

Color

This setting allows you to change the picture color effect. The file is saved as a new photo and stored in memory together with the original photo.

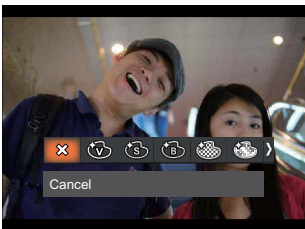

-  Cancel
-  Vivid
-  Sepia
-  Black and White
-  Grainy
-  Dreamy
-  Vignetting
-  Salon

Playback Settings Menu

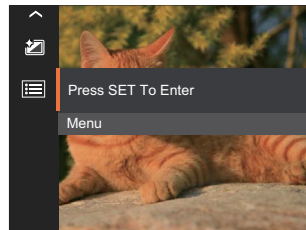

Press the  button to enter the menu.

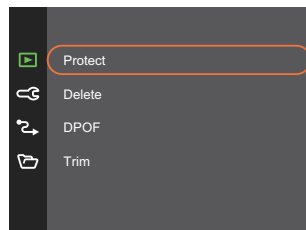

Protect

To prevent any pictures or videos from being accidentally erased, use this setting to lock one or all of the files stored on the memory card.





- One Lock the selected photo or video if they are unprotected; unlock the selected photo or video if they are protected.
- Date Folder Protect all photos in the Date Folder.
- All Lock all photos or videos.
- Reset Cancel all locked photos or videos.

Delete

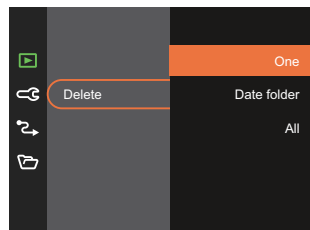
You can delete one or all photo/video files.



- One Delete one photo or video.
- Date Folder Delete all photos in the Date Folder.
- All Delete all photos or videos.

 The “” indicator means a file is protected. File protection must be removed before a file can be deleted.

 Deleting files will cause DPOF settings to be reset.

 Deleted files will be permanently deleted and will not be able to be recovered or restored.

DPOF (Digital Print Order Format)

The DPOF feature allows you to compile and select a group of pictures that you would like to print and will save your selection on the memory card so that you can use the memory card to print without having to individually specify the photos you want to print.

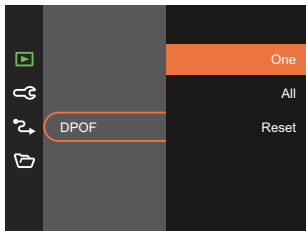





 A printer that supports DPOF is needed for photo printing.

Trim

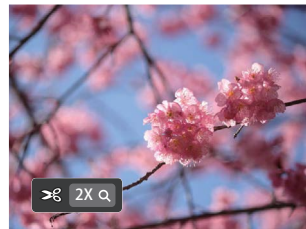
The Trim setting allows you to crop photos and save them as new pictures.

1. Select [Yes] to confirm trim. Select a section of the photo to be trimmed using the zoom button and arrow buttons to trim a photo.







2. Press the  button and the [Save change?] prompt appears. Select [] to change and save the picture. Select [] to cancel changes and return to the trim prompt screen.



 The image cannot be clipped/trimmed again once it has been clipped to 640 X 480.

General Settings

Mode:     SCN   

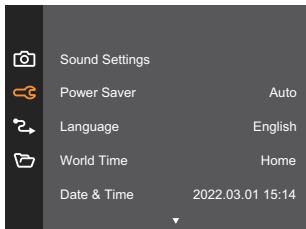
1. Press the  button and press the [▲ DISP.] / [▼ ⏏ ⏻] buttons to select . Press the  button to enter the menu.
2. Press the [▲ DISP.] / [▼ ⏏ ⏻] buttons to select  and press the  / [▶ ⚡] button to enter the menu.



3. Press the [▲ DISP.] / [▼ ⏏ ⏻] buttons to select the item to be set and press the  / [▶ ⚡] button to enter the menu.
4. Press the [▲ DISP.] / [▼ ⏏ ⏻] or [◀ ⏏] / [▶ ⚡] buttons to select an option, and press the  button to confirm.

Sound Settings

With this setting you may adjust the sound volume.

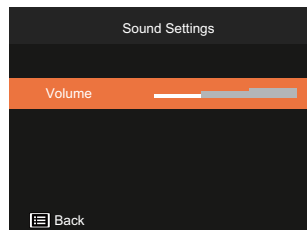

Power Saver

This setting allows you to save power and get the maximum possible running time for your camera's batteries.

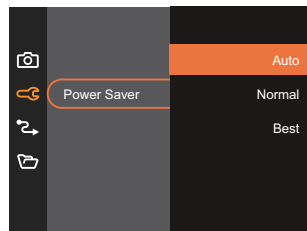

Language

Refer to the “Resetting your Language” section on page 19.

World Time

The Zone setting is a useful function for your overseas trips. This feature enables you to display the local time on the LCD while you are abroad.

1. Press the [▲ DISP.]/[▼ ⏻] buttons to select the departure place (🏠) and destination(🌐) fields.
2. Press the [◀ 🌿]/[▶ ⚡] buttons to select a city located in the same time zone as that of the field. Press the (SET) button to confirm settings.

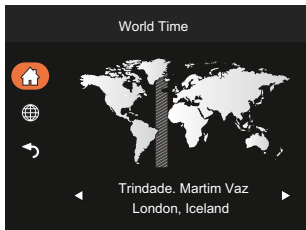

Date & Time

Refer to the “Resetting Date/Time” section on page 20.





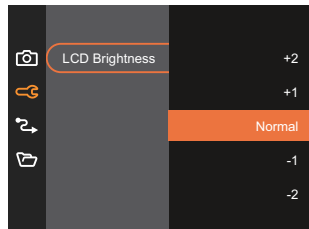

LCD Brightness

Use this setting to adjust the brightness of your LCD.



Connection Settings ↻

Mode:        

1. Press the  button and press the [▲ DISP.]/[▼ ⏻ ⏹] buttons to select . Press the  button to enter the menu.
2. Press the [▲ DISP.]/[▼ ⏻ ⏹] buttons to select  and press the  / [▶ ⚡] button to enter the menu.
3. Select [USB] and press the  / [▶ ⚡] button to enter the menu.

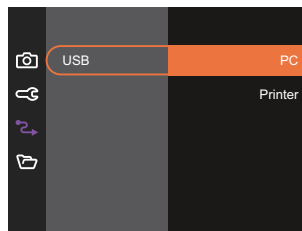
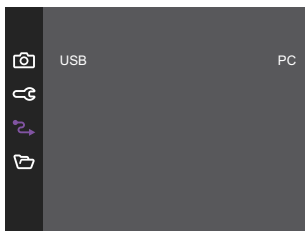

4. Press the [▲ DISP.]/[▼ ⏻ ⏹] buttons to select an option, and press the  button to confirm.

Connecting to a Computer

You can use a USB cable to connect the camera and copy (transmit) photos to a computer (PC or Mac), printer or other device.

Setting the USB Mode

Press the [▲ DISP.]/[▼ ⏻ ⏺] buttons to select [PC] and press the [SET] button to confirm.

Transferring Files to Your Computer

The computer will automatically detect the camera as a removable drive. Double-click the “My Computer” icon on the desktop to locate the removable drive and to copy folders and files in the drive to a directory on your computer as you would copy any typical folder or file.

Follow the steps below to connect the camera to a computer:

1. Make sure both the camera and computer are turned on
2. Connect one end of the supplied USB cable to the USB port on your camera.
3. Connect the other end of the cable to an available USB port on your computer
4. After the transmission is complete, disconnect the USB cable according to your computer manufacturer's instructions specifying how to safely remove USB devices.

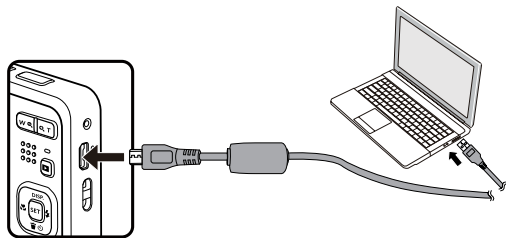

Connecting to PICTBRIDGE™ Compatible Printers



PICTBRIDGE™ technology allows printing of the photos saved on the memory card by a printer.

To find out if a printer is PICTBRIDGE™ compatible, simply look for the PICTBRIDGE™ logo on the packaging or check the owner's manual for specifications. With the PICTBRIDGE™ function on your camera, you can print the captured photos directly to a PICTBRIDGE™ compatible printer using the supplied USB cable, without the need for a computer.

Setting the USB Mode

Press the [▲ DISP.]/[▼ ⏻ ⏺] buttons to select [Printer] and press the [SET] button to confirm.

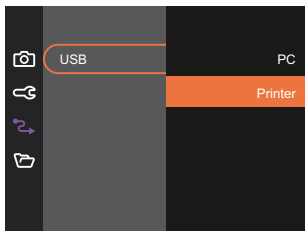

After the camera is reset, it will switch to PC mode automatically from USB Mode.



See "Using the PICTBRIDGE™ Menu" section on page 68.

Connecting to your Printer

1. Make sure both the camera and printer are turned on.
2. Connect one end of the supplied USB cable to the USB port on your camera.
3. Connect the other end of the cable to the USB port on the printer.

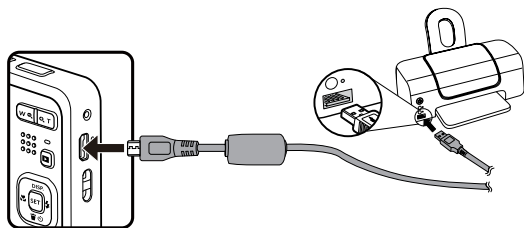

If the camera is not connected to a PICTBRIDGE™ compatible printer, the following error message will appear on the LCD.

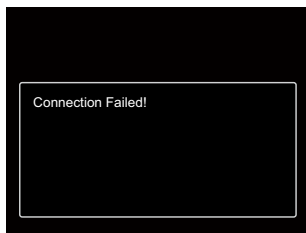

The error message above will also appear if the USB Mode is set incorrectly, in which case you should disconnect the USB cable, check the USB Mode settings, ensure that the printer is turned on, and then try connecting the USB cable again.

Using the PICTBRIDGE™ Menu

After setting the USB mode to Printer, the PICTBRIDGE™ menu will appear.

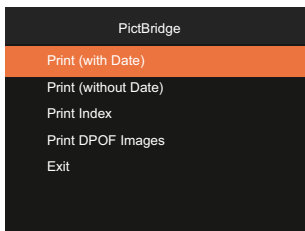

Press the [▲ DISP.]/[▼ 🗑️] buttons to select a menu item and press the [SET] / [▶ ⚡] button to enter the item.

Print (with Date)/Print (without Date)

If you have set the date and time on your camera, the date and time will be recorded and saved with each photo you take. You can use function of [Print (with Date)] to print out the photos together with the date.

1. In the PICTBRIDGE™ menu, select [Print (with Date)]/ [Print (without Date)] and the screen as shown below appears.

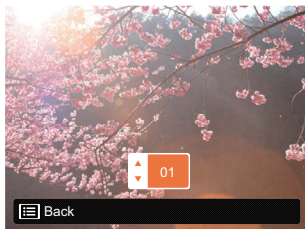

2. Press the []/[] buttons to select a photo to be printed.
3. Press the [DISP.]/[] buttons to select the number of copies for the currently displayed photo.
4. Press the button and the following screen will appear.

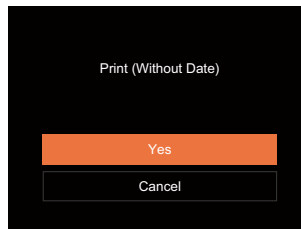
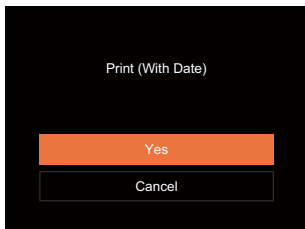

5. Select [Yes] and press the button to confirm; select [Cancel] to cancel printing.

Print Index

You can print all photos in the camera via this function.

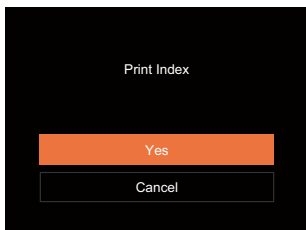

Print DPOF Images

To use DPOF printing, you must select your photos for printing using the DPOF settings before hand. See "DPOF" section on page 61.

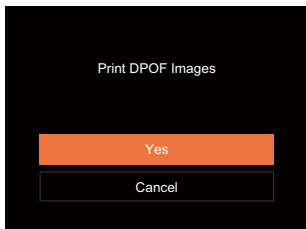

Exit

Select [Exit] to exit the PICTBRIDGE™ menu. At this time, the message [Remove USB Cable!] will appear on the screen.

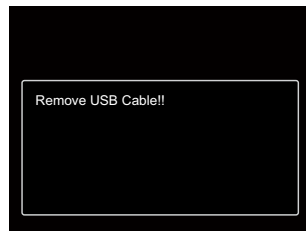



Disconnect the USB cable from the camera and printer.

File Settings

Mode:        

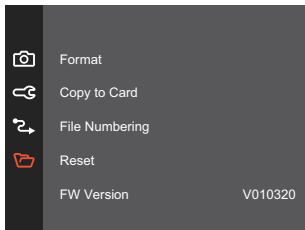
1. Press the  button and press the [▲ DISP.]/[▼ ⏻ ⏹] buttons to select . Press the  button to enter the menu.
2. Press the [▲ DISP.]/[▼ ⏻ ⏹] buttons to select  and press the  / [▶ ⚡] button to enter the menu.



3. Press the [▲ DISP.]/[▼ ⏻ ⏹] buttons to select the item to be set and press the  / [▶ ⚡] button to enter the menu.
4. Press the [▲ DISP.]/[▼ ⏻ ⏹] button to select an option and press the  button to confirm.

Format

Please Note: formatting enables you to delete all contents on the memory card and camera's built-in memory, including protected photo and movie files.

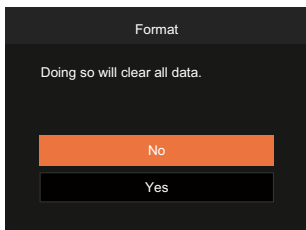

Copy to Card

Use this setting to copy the files stored in the camera's built-in memory to a memory card.

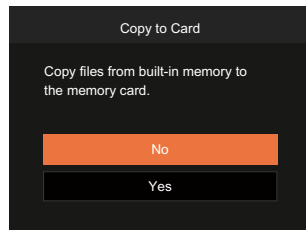

If there is no memory card in the camera, the built-in memory will be formatted; if there is a memory card, only the memory card will be formatted.



If there is no card available in the camera, this function will not be displayed.

File Numbering

After you take a picture or video clip, the camera will automatically save it with a sequential number. You can use this to reset the file numbering to 1.

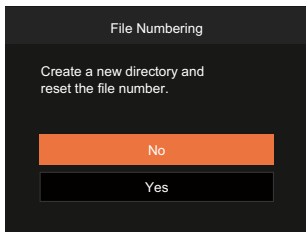

Reset

Use this setting to restore the camera to its original factory default settings.

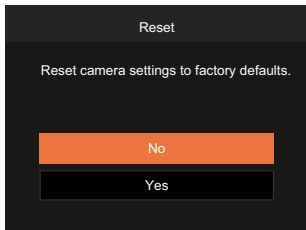

Firmware (FW) Version

Use this setting to view the current camera firmware version.

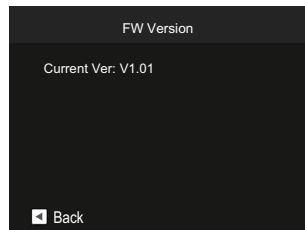

When there is a new firmware version in the SD card, select [Yes] to update.

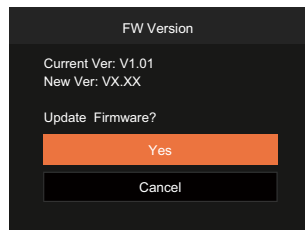

APPENDICES

Specifications



Design and specifications are subject to change without notice.

Image Sensor	Type	1/2.3"BSI CMOS
	Effective Pixels	16.35Megapixels
	Total Pixels	16.76 Megapixels
Lens	Focal Length	5.1mm (Wide) – 25.5mm (Tele)
	35mm Film Equivalent	28mm (Wide) – 140mm (Tele)
	F Number	F3.9 (Wide) – F6.3 (Tele)
	Lens Construction	8 groups 8 elements
	Optical Zoom	5x
	Focusing Range	Normal: (Wide) 60cm ~ ∞ (Tele) 100cm ~ ∞ Macro: 5cm ~ ∞ (Wide Only)
Autofocus System		TTL Autofocus
Anti-Handshake		Digital Image Stabilization
Digital Zoom		6x Digital Zoom (Combined Zoom: 30x)

Number of Recording Pixels	Still Image	(4:3) 16MP: 4608 × 3456 10MP: 3648 × 2736 5MP: 2592 × 1944 3MP: 2048 × 1536 0.3MP: 640 × 480	(3:2) 14MP: 4608 × 3072	(16:9) 12MP: 4608 × 2592 2MP: 1920 × 1080
	Movie	1920 × 1080 (30fps), 1280 × 720 (60fps), 1280 × 720 (30fps), 640 × 480 (30fps), High-Speed Movie: 640 × 480 (120fps)		
Image Compression		Best, Fine, Normal		
DCF, DPOF (Ver1.1) Support		Yes		
File Format	Still Image	Exif 2.3 (JPEG)		
	Movie	Movie Format: MOV (Motion JPEG), Audio: Linear PCM [Monaural]		
Shooting Modes		Auto Mode, Program AE, Manual Mode, Movie Mode, Scene Mode, Panorama Mode, Face Beautifier		
Scene Mode		Auto Scene, Night Landscape, Pet Mode, Snow, Party, Sport, Night Portrait, Portrait, Children, Landscape, Sunset, Fireworks, Beach, Anti-shake		
Detection Features		Face, Smile, Blink, Cat, Dog		
Photo Touch-up		Red-Eye Reduction, Skin Soften, Eye Brightening, Eye Enlargement		
HDR		Yes		

Pan-Panorama	Max 180°(Horizontal)
LCD Display	2.7 inch (230k Pixels)
ISO Sensitivity	Auto, ISO100/200/400/800/1600/3200
AF Method	Single AF, Multi-AF (TTL 9-point), Object Tracking, Face-Detection
Exposure Metering Method	Artificial Intelligence AE (AiAE), Center-Weighted Average, Spot (Fixed to Center of Frame), Face AE
Exposure Control Method	Program AE (AE-Lock Available)
Exposure Compensation	±3EV in 1/3 Step Increments
Shutter Speed	1/2000 ~ 4 Seconds (Manual: 30 Seconds)
Continuous Shooting	Yes
Playback Modes	Single Photo, Index (9/16 Thumbnails), Slide Show, Date Mode
	Zoom (Approx. x2 ~ x8)
White Balance Control	AWB, Daylight, Cloudy, Fluorescent, Fluorescent CWF, Incandescent, Manual WB, Color Temp. (1900K-10000K)

Flash	Flash Method	Internal
	Flash Modes	Force Off, Flash Auto, Force Flash, Slow Sync., Slow Sync. + Red-Eye Reduction, Red-Eye Reduction
	Shooting Range	(Wide) Approx. 0.3m ~ 3.9m (ISO800) (Tele) Approx. 1.2m ~ 2.4m (ISO800)
	Recycling Time	6 seconds or less
Recording Media		Internal Memory: Approx. 63MB SD/SDHC/SDXC Card (Up to 512GB Support) [MMC Card not supported]
PICTBRIDGE™, ExifPrint Support		Yes
Multi-Language Support		27 Languages
Jacks		USB 2.0 (Micro 5 pin USB)
Power		Rechargeable Li-ion Battery LB-012, 3.7V 700mAh, In-Camera Charging
Battery Charging Time		Approx. 2H (Use AC Adapter and Battery is Exhausted)
Shooting Capability (Battery Performance)		Approx. 200 Shots (Based on CIPA Standards) Approx. 1h 30min for Video (@1080/30fps)
Operation Environment		Temperature: 0 ~ 40°C, Humidity: 0 ~ 90%
Dimensions (W×H×D)		Approx. 91.5 × 56.5 × 22.9mm (Based on CIPA Standards)
Weight		Approx. 106g (Body Only)

Prompts and Warning Messages

Message	Description	Action
Warning! Battery exhausted.	The camera battery is depleted. It is a warning indicating that the camera is going to shut off.	Recharge the Li-ion battery or replace with fully charged spare Li-ion battery. The camera will shut down in 2 seconds.
Lens obstruction, Re-start Camera.	The lens is jammed or some foreign object is preventing the lens from functioning properly.	Turn the camera off and restart it to reset the lens.
Suggest using tripod.	When continuous exposure is enabled, this prompt message is displayed when the photo shooting screen is displayed for the first time.	This message will disappear after 2 seconds.
Battery temperature is too high.	The battery temperature reaches 53.5 °C.	Let the battery cool before attempting to use the camera again. This message will disappear after 2 seconds
Built-in memory error!	An error has occurred in the internal memory.	Try shutting down the camera and turning it on again. This message will disappear after 2 seconds
Improper alignment. Please try again.	The offset is too big for panorama shooting.	This message will disappear after 2 seconds.

Message	Description	Action
Warning! Do not turn off your camera during update!	This message appears during the firmware update process.	This message disappears after the camera update and restart.
Remove USB cable!!	Indicates that you can disconnect the USB cable.	The message disappears after you disconnect the USB cable.
Connection Failed!	Failure to connect to your computer or printer.	Remove USB cable and retry connection.
Please update firmware after the battery is fully charged!	The firmware cannot be updated when power is insufficient.	A message appears to prompt updating after full charging and returning to the update screen.
Write Protect !	The memory card is locked.	Remove memory card and switch the lever on the side of card to UNLOCK. This message will disappear after 2 seconds.
Card Full !	Indicates that the memory card is full.	Replace memory card with another that has available memory. This message will disappear after 2 seconds.
Memory Full !	Indicates that the camera memory is full.	It will disappear after 2 seconds.

Message	Description	Action
Card Error !	During power-on, the memory card cannot be recognized or a read/write error has occurred.	Format the memory card. WARNING: Formatting the memory card will erase all data on the card. Copy the data from the memory card to another storage, such as a computer. Otherwise, all data will be erased after the format. This message will disappear after 2 seconds.
Card is not formatted.	When an error occurs in the memory card, the message "Not Formatted" will appear.	Format the memory card. WARNING: Formatting the memory card will erase all data on the card. Copy the data from the memory card to another storage, such as a computer. Otherwise, all data will be erased after the format.
Slow access!	When a memory card lower than Class 10 is used to record a HD movie, the writing speed will be slower and recording will not continue.	Replace the memory card with a higher Class over 10. This message will disappear after 2 seconds.
Cannot write to SD card.	The photo shooting or video recording has been interrupted, so recording cannot continue.	Turn the camera off. Then unload and reload the memory card and turn on the camera to restart. Also check if memory card is full or in the locked position.
No Red-Eye Detected!	Red eyes have not been detected in the image.	This message will disappear after 2 seconds.

Message	Description	Action
This image cannot be edited.	The file format does not support editing or the edited file cannot be edited again.	This message will disappear after 2 seconds.
Exceeded maximum folder number.	This indicates that the memory card exceeded the maximum number of folders (999). This could cause a long read time during the camera's power up.	Copy the data to your PC and format the memory card using the camera.
Too many pictures for fast processing.	During the playback by date, the images exceed specifications so that it is not possible to play by date.	The message disappears after 2 seconds and the camera returns to normal playback mode.
Unable to recognize files.	The format of the file to be viewed is not supported or the file is corrupted so it cannot be properly read.	This message disappears only after the file is deleted.
No Picture!	When you press the play button, no image files exist in the camera or on memory card.	This message disappears after 2 seconds and returns to the photo shooting screen.
Protected! Undeletable!	The file is protected. The message appears when you go into delete mode.	Remove memory card and switch the lever on the side of card to UNLOCK. Place card back into the camera and try again. This message will disappear after 2 seconds.

Troubleshooting

Problem	Possible causes	Solution
Camera does not turn on	<ul style="list-style-type: none">■ The battery has been depleted.■ The battery is not inserted correctly.	<ul style="list-style-type: none">■ Replace the battery.■ Correctly reinstall the battery.
Camera turns off suddenly during operation	<ul style="list-style-type: none">■ The battery has been depleted.	<ul style="list-style-type: none">■ Replace the battery.
The picture is blurred	<ul style="list-style-type: none">■ Camera movement while taking a picture.	<ul style="list-style-type: none">■ Turn on Anti-shake mode.
Images and video files cannot be saved	<ul style="list-style-type: none">■ The memory card is full.■ The memory card is locked.	<ul style="list-style-type: none">■ Use another memory card or delete unnecessary files.■ Unlock the memory card.
Images will not print from the connected printer	<ul style="list-style-type: none">■ The camera is not connected to the printer correctly.■ The printer is not PICTBRIDGE™ compatible.■ The printer is out of paper or ink.■ The printer paper is jammed.	<ul style="list-style-type: none">■ Check the connection between the camera and printer.■ Use a PICTBRIDGE™ compatible printer.■ Load paper into the printer or replace the ink cartridge in the printer.■ Remove the jammed paper.

Problem	Possible causes	Solution
Saving data to memory card is slow	<ul style="list-style-type: none"> ■ Using a memory card below Class 10 may result in slower recording times. 	<ul style="list-style-type: none"> ■ Use a memory card with Class 10 or higher standard to improve performance.
Cannot write to the memory card	<ul style="list-style-type: none"> ■ The memory card has been locked. 	<ul style="list-style-type: none"> ■ Release the write lock of the memory card or replace with another card.
Too many movies to process	<ul style="list-style-type: none"> ■ The number of pictures or folders in the memory card exceed the specifications, so the playback can not be displayed. 	<ul style="list-style-type: none"> ■ Delete unwanted files.
The flash  flashes on the LCD screen.	<ul style="list-style-type: none"> ■ Current shooting environment requires flash. 	<ul style="list-style-type: none"> ■ Turn on flash.

Memory Card Compatibility

• Cards compatible with this camera (√ : Compatible X: Not Compatible)

	micro SD	micro SDHC	micro SDXC	Conversion adapter to SD card	SD	SDHC	SDXC
Format	FAT12, 16	FAT32	exFAT	-	FAT12, 16	FAT32	exFAT
Capacity	Up to 2GB	4-32GB	64GB-2TB	-	Up to 2GB	4-32GB	64GB-2TB
Compatibility	X	X	X	√	√	√	√

It indicates that the writing speed class will be displayed on the memory card.

Use a memory card with the appropriate writing speed for the video recording mode to be recorded.

(O: Recommended X: Not recommended)

	Speed Class	UHS Speed Class	Video Speed Class	Video Recording			
				4K	FHD	HD	VGA
90MB/sec			V90	O	O	O	O
60MB/sec		UHS-III	V60	O	O	O	O
30MB/sec		UHS-I	V30	O	O	O	O
10MB/sec	Class 10		V10	O	O	O	O
6MB/sec	Class 6		V6	X	O	O	O
4MB/sec	Class 4			X	X	X	O
2MB/sec	Class 2			X	X	X	O

© 2022 JK Imaging Ltd. All Rights Reserved.

The Kodak trademark, logo and trade dress are used under license from Eastman Kodak Company.

All other logos, products or company names that are referred to in this document are trade names, trademarks or registered trademarks of their holders. The holders are not affiliated with JK Imaging Ltd., our products or our website.

JK Imaging Ltd., 17239 So. Main Street, Gardena, CA 90248 USA

kodakpixpro.com

Made in Myanmar (Burma)

Document No/Sequence: U.DIS.0062.0222.en.01

